

826 pH mobile / 827 pH lab



Manual
8.827.8001EN



Metrohm AG
CH-9100 Herisau
Switzerland
Phone +41 71 353 85 85
Fax +41 71 353 89 01
info@metrohm.com
www.metrohm.com

826 pH mobile / 827 pH lab

Program version 5.826.0011 and 5.827.0011

Manual

Teachware
Metrohm AG
CH-9100 Herisau
teachware@metrohm.com

This documentation is protected by copyright. All rights reserved.

Although all the information given in this documentation has been checked with great care, errors cannot be entirely excluded. Should you notice any mistakes please send us your comments using the address given above.

Documentation in additional languages can be found on
<http://documents.metrohm.com>.

Table of contents

1	Introduction.....	1
1.1	Instrument description.....	1
1.2	Parts and controls.....	2
1.3	Information about these Instructions for Use.....	4
1.3.1	Notation and pictograms.....	4
1.4	Safety information.....	5
1.4.1	Electrical safety.....	5
1.4.2	General handling rules.....	5
2	Installation.....	7
2.1	Instrument setup.....	7
2.1.1	Packaging.....	7
2.1.2	Checks.....	7
2.1.3	Location.....	7
2.2	Inserting the batteries at 826 pH mobile.....	7
2.3	Connecting the electrodes and sensors.....	7
2.4	Mains connection.....	8
2.5	Switch on.....	8
2.6	Connecting a printer.....	9
2.7	Initial configuration.....	9
3	Operation.....	11
3.1	Operating concept.....	11
3.2	All key functions at a glance.....	12
3.3	Operating principles.....	14
3.3.1	Configuration and method parameters.....	14
3.3.2	Editing menu entries.....	14
3.3.3	Entering text and numbers.....	15
4	Short operating tutorial.....	17
4.1	Requirements.....	17
4.2	pH calibration.....	17
4.3	pH measurement.....	19
5	Configuration.....	21
5.1	Report.....	21
5.2	Printing out measured values.....	22
5.3	Storing measured values.....	25
5.4	Auxiliaries.....	26
6	Methods / Parameters.....	29
6.1	pH measurement (pH mode).....	29
6.1.1	Measuring parameters.....	29
6.1.2	Calibration parameters.....	30
6.1.3	Limits.....	32
6.1.4	pH calibration data.....	33

6.2	Temperature measurement (T mode).....	34
6.3	Potential measurement (U mode).....	34
7	Various functions	35
7.1	Reports	35
7.1.1	Arrangement of a report.....	36
7.1.2	Report identification	36
7.1.3	Measuring point report.....	37
7.1.4	Calibration report	37
7.1.5	Configuration report	37
7.1.6	Parameter report	38
7.1.7	Measured values memory report.....	38
7.1.8	PC/LIMS report.....	38
7.1.9	System test report	39
7.2	Measured values memory.....	40
7.2.1	Store measured values	40
7.2.2	Print measured values	40
7.2.3	Show measured values.....	40
7.3	Setup	42
7.3.1	Locking.....	42
8	Troubleshooting – Messages – Maintenance.....	43
8.1	Troubleshooting.....	43
8.2	Messages	45
8.3	Diagnosis	47
8.4	Maintenance.....	49
8.4.1	Changing the batteries (826 only)	49
8.4.2	Changing the batteries (827 only)	50
9	Appendix.....	51
9.1	Technical data.....	51
9.1.1	Measuring modes	51
9.1.2	Measuring inputs.....	51
9.1.3	Measuring input specifications	52
9.1.4	Measured values memory	52
9.1.5	Display.....	52
9.1.6	Interfaces.....	52
9.1.7	Power supply.....	52
9.1.8	Housing specifications.....	52
9.1.9	Safety specifications	53
9.1.10	Electromagnetic compatibility (EMC)	53
9.1.11	Ambient temperature	53
9.1.12	Reference conditions	53
9.1.13	Dimensions	53
9.2	Menu structures	55
9.2.1	Instrument configuration	55
9.2.2	Parameters in the pH mode.....	56
9.2.3	Parameters in the T mode.....	56
9.2.4	Parameters in the U mode	56
9.3	Stored buffer series	57

9.4	Scope of delivery	62
9.4.1	826 pH mobile	62
9.4.2	Optional accessories for 826 pH mobile	65
9.4.3	827 pH lab	65
9.4.4	Optional accessories for 827 pH lab	67
9.5	Warranty and conformity	68
9.5.1	Warranty.....	68
9.5.2	Declaration of Conformity	69
9.5.3	Declaration of Conformity	70
9.5.4	Quality Management Principles	71
10	Index.....	73

List of illustrations

Fig. 1: pH meter 827	1
Fig. 2: Front view of the 827 pH lab.....	2
Fig. 3: Rear view of the 827 pH lab	3
Fig. 4: Connecting sensors.....	8
Fig. 5: Changing the batteries for the 826 pH mobile.....	49
Fig. 6: Changing the batteries for the 827 pH lab.....	50

1 Introduction

These instructions provide you with a comprehensive overview of the installation, working principles and operation of the **826 pH mobile** and **827 pH lab**.

Additional theoretical principles can be found in the Metrohm Monograph 8.015.5013 "**Electrodes in Potentiometry**".

You can also request our descriptions of applications involving pH measurements in the form of **Application Notes** and **Application Bulletins** from your local Metrohm agency or download them from the Internet under www.metrohm.com.



Fig. 1: pH meter 827

1.1 Instrument description

Both instrument versions, the portable **826 pH mobile** and the laboratory device **827 pH lab**, are used for measuring pH, temperature and potential reliably. The functional range is identical. The pH meter **826 pH mobile** is operated with batteries whereas the **827 pH lab** has got an external power supply.

Up to 200 values can be stored in the memory together with the most important additional data; these can be viewed and printed as a report.

All stored information (measured values, configuration, parameters, etc.) can be transmitted via the infrared interface to a printer or computer for output as a report.

Both instruments have the following features:

- Dot-matrix display for both the continuous display of the measured value and for showing the user dialog.
- High-impedance measuring input for pH, redox or ISE sensors, a connection for a separate reference electrode and an input for temperature sensors (NTC or Pt1000).
- Infrared interface for a infrared printer.

1.2 Parts and controls

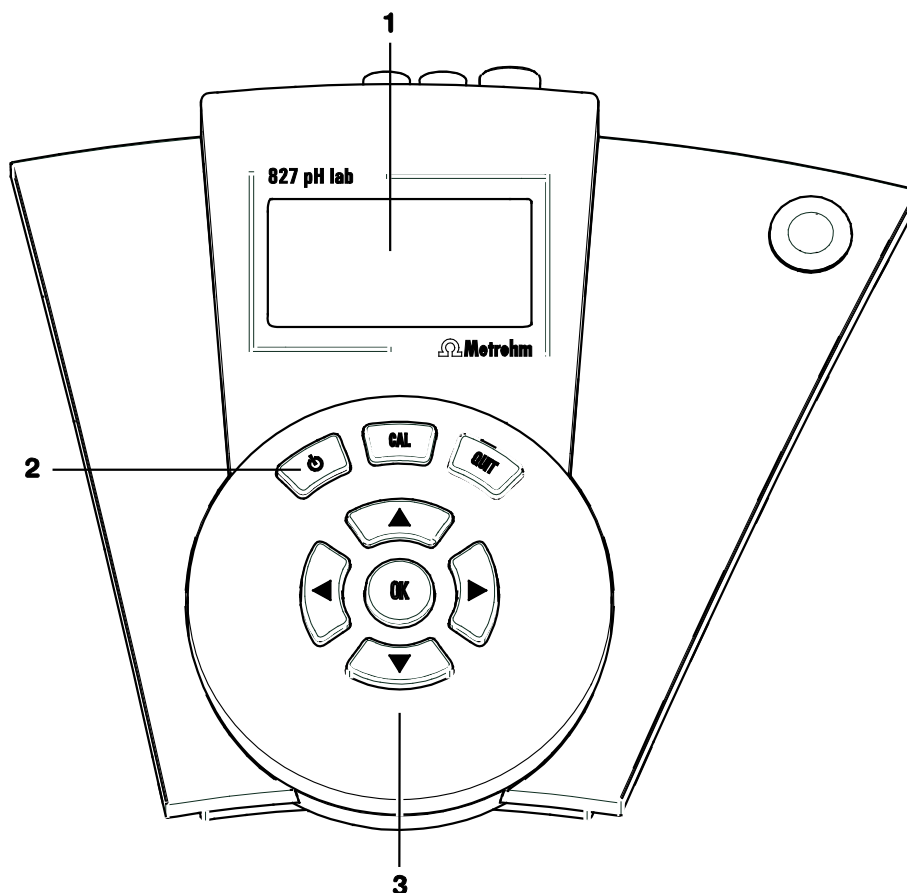

Fig. 2: Front view of the 827 pH lab

1 LCD display

3 Input and navigation keys

Menu selection, text and number input

2 On/Off key

Key for switching the instrument on and off

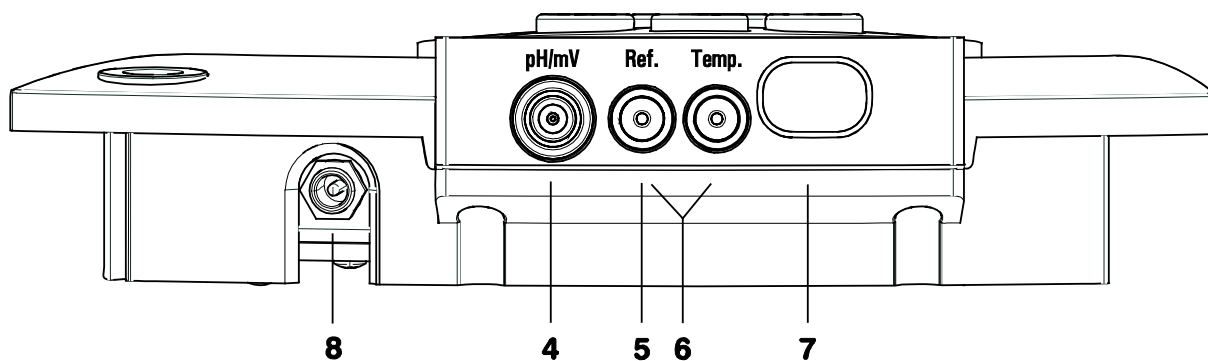

Fig. 3: Rear view of the 827 pH lab

4 Connection for potentiometric electrodes
 pH, ISE, redox or silver electrodes with built-in or separate reference electrode; socket type F

7 Infrared interface
 Connection for printer or PC with infrared interface

5 Connection for separate reference electrode
 for connection with two 2 mm B-plugs; the adapter 6.2103.180 or 6.2103.190 is necessary with 4 mm banana plugs

8 6 V power connection
 with 827 pH lab only

6 Connection for temperature sensor
 Pt1000 or NTC, for connection with two 2 mm B-plugs; the adapters 6.2103.180 and 6.2103.190 are necessary with 4 mm banana plugs; red plug in socket "Temp."!

1.3 Information about these Instructions for Use







Attention!

Please study these instructions carefully before you start to use the instrument. The instructions contain information and warnings that must be observed by the user in order to guarantee the safe use of the instrument.

1.3.1 Notation and pictograms

The following notations and pictograms (symbols) are used in these instructions:

Parameter	Menu item, parameter or input value
<< config >>	Menu
<OK>	Key
4	Operating element
	Danger This symbol indicates a possible risk of death or injury if the given information is not properly observed.
	Warning This symbol indicates a possible risk of damage to the instrument or its components if the given information is not properly observed.
	Attention This symbol indicates important information. Please read it carefully before you continue.
	Information This symbol indicates additional information and tips.

1.4 Safety information



Warning!

This instrument should only be used in accordance with the information given in these installation instructions.

1.4.1 Electrical safety

Please observe the following guidelines:

- Only qualified Metrohm technicians should carry out service work on electronic components.
- Open the housing only in order to change the batteries. There are no components inside the housing that the user can service or exchange. The changing of the batteries is described in *Section 8.4*.

Electrical safety when handling the pH meter is guaranteed within the framework of the IEC 61010-1 Standard. The following points must be observed:



Danger!

Please make sure that the external power supply is always kept dry. Protect it against direct liquid contact.



Warning!

Electronic components are sensitive to electrostatic charges and can be destroyed by a discharge. Always switch off the pH meter before making or breaking electrical connections on the rear panel of the instrument.

1.4.2 General handling rules

Handling solutions



Warning!

When working with water or other solutions in the immediate vicinity of the pH meter please avoid excessive liquid splashes on the instrument housing or power supply. Any such splashes must be removed as quickly as possible in order to prevent the liquid from entering the instrument or the power supply.

Do not clean the plexiglass display with organic solvents like e. g. acetone.

2 Installation

2.1 Instrument setup

2.1.1 Packaging

The 826/827 pH meter and its specially packed accessories are supplied in very protective special packaging. Please store this packaging in a safe place; it is the only way in which the safe transport of the instrument can be guaranteed.

2.1.2 Checks

Please check that the delivery is complete and undamaged immediately on receipt (compare with delivery note and list of accessories given in *Section 9.4*).

2.1.3 Location

Place the instrument on a suitable vibration-free laboratory bench, protected from corrosive atmospheres and contact with chemicals.

2.2 Inserting the batteries at 826 pH mobile

The 826 pH mobile is delivered without inserted batteries. Inserting the batteries is described in *Section 8.4.1*.

2.3 Connecting the electrodes and sensors

On its rear panel the 826/827 pH meter has connections for a potentiometric electrode **4**, a separate reference electrode **5** and a temperature sensor **6**.

Connect your electrodes and sensors according to the following diagram to the **switched off** pH meter:

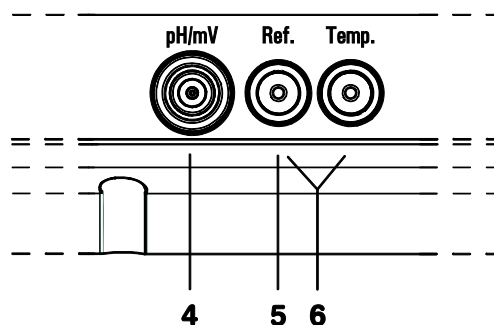

Fig. 4: Connecting sensors

4 Connection for potentiometric electrodes

pH, ISE, redox or silver electrodes with built-in or separate reference electrode; plug F

5 Connection for separate reference electrode

6 Connection for temperature sensor

Pt1000 or NTC, connected via two 2 mm banana plugs, reducing adapters for 4 mm plug B may be necessary (6.2103.180 / 6.2103.190). Please observe: The red plug must be put in the socket "Temp." for shielding purposes!

2.4 Mains connection

The 827 pH lab has an external power supply providing 6 V (DC). This is connected to 6 V mains connection **8**.

The following power supply units are available:

- 6.2161.010 power supply unit EU 230 V / 6 V DC
- 6.2161.020 power supply unit US 115 V / 6 V DC
- 6.2161.030 power supply unit UK 230 V / 6 V DC
- 6.2161.040 power supply unit AUS 240 V / 6 V DC



Attention!

Please make sure that the power supply is always kept dry. Protect it against direct liquid contact.

2.5 Switch on



Switch on the pH meter with the <power> key. The instrument will start in the last operating mode to have been used for measuring pH, temperature or potential.

During the switch-on process an instrument checking routine is carried out automatically. If an error message is displayed here ('Err x') then please contact your local Metrohm agency.

2.6 Connecting a printer

A printer with an infrared interface can be connected to the infrared interface for printing out reports.

Activate the infrared interface of the pH meter under

`configuration/auxil/IR interface:` (see Section 5.4)

No further transmission parameters need to be set.

**Attention!**

In order to guarantee a perfect transmission the distance between the pH meter and the printer should be 80 cm at the maximum. The infrared interfaces must face each other directly. Never expose the infrared interface to direct sunlight.

2.7 Initial configuration

The pH meter is delivered with standard settings for the configuration. If it should ever be necessary to reset the configuration of the instrument to its original condition then this can be carried out by a re-initialization of the instrument memory (see Section 8.3).

Before you start to make measurements please change the following configuration settings. If you first want to make yourself familiar with the operation of the pH meter then please read Sections 3.1 to 3.3. More detailed explanations of the individual configuration settings are given in Section 5.

Date and time

`configuration/auxil/date`
and `/time`

Please check that the date and time are correct.

Temperature sensor

`configuration/auxil/temp.sens.`

Enter the type of temperature sensor that is connected. If no temperature sensor is connected and you always want to enter the measuring temperature manually then you can ignore this setting.

3 Operation

3.1 Operating concept

The pH meter provides two types of display:

1. The **measured value display**.
This is the normal instrument display.

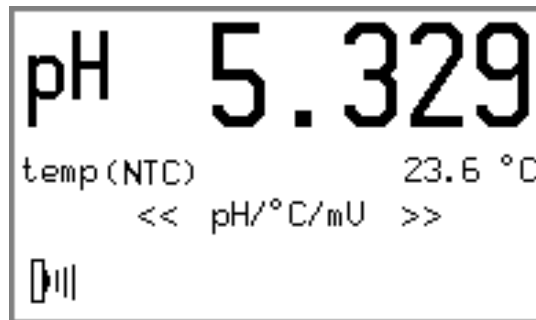



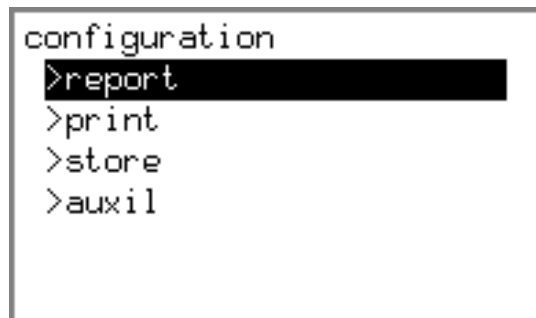

2. The **menu display**
This is used for editing various settings.





In the **measured value display** the current measured value is shown together with the method of the temperature measurement (only for mode pH) and the date and time (only for modes U and T) respectively. The measured value display changes when the operating mode of the pH meter is changed with **<OK>** in the menu **<< pH/°C/mV >>**. You can easily see which mode is set from the measuring unit or the prefix "pH" shown in the display.

3.2 All key functions at a glance

The functions of all the keys are described below both for the measured value display and the menu display:

Key	Measured value display	Menu display
	On/Off <ul style="list-style-type: none"> The <⏻> key switches the instrument on and off. After switching-on the pH meter is in the initial state of the last mode to have been used. 	On/Off <ul style="list-style-type: none"> The <⏻> key switches the instrument off at any time.
	Starting calibration <ul style="list-style-type: none"> The <CAL> key starts the pH calibration (in mode pH only). 	
	Acknowledging messages <ul style="list-style-type: none"> Displayed messages are normally acknowledged with <QUIT> (Exceptions: see <i>Section 8.2</i>). If the cause of the message has not been remedied, then it will appear again at the next check. 	Canceling working step <ul style="list-style-type: none"> In menus <QUIT> causes a jump to the next higher level without accepting the alterations.
	Menu selection <ul style="list-style-type: none"> The menu is being changed with the arrow keys <◀> and <▶>. 	Selecting predefined entries <ul style="list-style-type: none"> For menu parameters which offer a fixed choice of settings (recognizable by the final colon) the selection list can be viewed with the arrow keys. The arrow determines the selection direction. Cursor control for text input <ul style="list-style-type: none"> The cursor is moved to that position which needs to be altered.

Key	Measured value display	Menu display
 	<p>Altering display contrast</p> <ul style="list-style-type: none"> The contrast of the LCD display can be altered with the arrow keys <▲> and <▼> during the measured value display. This setting is retained after the instrument has been switched off and on. The default value is only reset after the memory has been initialized. 	<p>Controlling the menu bar</p> <ul style="list-style-type: none"> In each menu display the <▲> and <▼> keys can be used to move the selection bar up and down by one line. <p>Cursor control for text input</p> <ul style="list-style-type: none"> The character to be entered is selected with the arrow keys and entered with <OK>. <p>Leafing through the measured value memory</p> <ul style="list-style-type: none"> Leafing through between the entries in the measured value memory display: starting from the last measured value having been stored you can access older entries with <▲> and vice versa.
	<p>Calibration</p> <ul style="list-style-type: none"> The calibration sequence is continued with <OK>. The calibration data are accepted with <OK> in case they are out of the defined limits. 	<p>Confirming entry</p> <ul style="list-style-type: none"> The <OK> key is used to complete each entry with the selection bar moving on to the next parameter. If an entry is exited without this confirmation then the entered value will be rejected.

3.3 Operating principles

3.3.1 Configuration and method parameters

Instrument configuration and parameters for the pH mode (no adjustable parameters are required for the measuring modes U (mV) and T (°C)) are each contained in menus with a tree structure. These menu structures are shown in the appendix in *Section 9.2*.

The instrument configuration of the pH meter is described in the menu **<< config >>**. This contains the basic settings that apply for all measuring modes. The parameters for the pH mode are stored in the menu **<< param >>**.

The change from the measured value display to the menu display is made by selecting the corresponding menu and confirming with the **<OK>** key. The title of the submenu appears first, and is shown with an '>' (e. g. **>report**). You can now move the selection bar up and down with the **<▲>** and **<▼>** arrow keys. Each underlying level in the menu structure is opened with **<OK>** and exited with **<QUIT>**. Alterations to individual entries must be confirmed with **<OK>**. If such alterations are exited with **<QUIT>** then they remain ineffective.

If an entry is confirmed with **<OK>** then the selection bar will move to the next entry. At the end of a submenu it will finally change to the next point of the superior menu selection.

In this way you can run through the complete menu structure for the configuration and parameters by repeatedly pressing the **<OK>** key. This can be helpful when carrying out checks.

Not all parts of the menu structure described below are visible in the display at all times. Only the specific possible settings of the option which is currently activated are shown. For example, the various settings for printing under **configuration/print/print crit.** are not visible when printing has been deactivated completely (**off**). If one of the other printing criteria is selected then the particular settings it requires will appear in the display.

3.3.2 Editing menu entries

A basic differentiation is made between two types of menu entry.

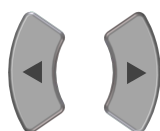

Entries with a fixed selection are indicated by a colon:

print crit.: **immed.**, time, drift, change, off

The selection is then made with the arrow keys and confirmed with **<OK>**.



Entries which can be edited are altered by entering a new value and confirming it with **<OK>**.

3.3.3 Entering text and numbers

The editing of text and number inputs is activated with the <◀> or <▶> key. The first digit of the entry field will be displayed inverted for text entries whereas it is the last digit for number entries. The cursor can be moved to the position to be changed with the <◀> or <▶> key.

The desired character can be selected from a cylinder with the <▲> or <▼> keys. The cursor movement can be accelerated by keeping the arrow keys pressed down.

The following characters can be selected:

- For ASCII entry fields:
a, b, c, d, e, f, g, h, i, j, k, l, m, n, o, p, q, r, s, t, u, v, w, x, y, z, 0, 1, 2, 3, 4, 5, 6, 7, 8, 9, ., -, empty
- For number entry fields:
0, 1, 2, 3, 4, 5, 6, 7, 8, 9, ., -, empty

The entry is checked for validity and accepted if it is valid. Otherwise the entered value is blinking and it can be corrected. If a space has been entered between two numbers of a number entry, the display is blinking as well. The value can be corrected then or the original value is entered by pressing <QUIT>. The editing can be exited with <QUIT> without storing the setting.

4 Short operating tutorial

In this section the necessary steps for carrying out a simple pH and ion measurement with calibration are described. The instructions are limited to those steps that are absolutely necessary and will enable you to carry out your first measurements with the pH meter directly. The operating principles are described in *Section 3.3*.

4.1 Requirements

The following instruments, accessories and solutions are required for carrying out the pH calibration and measurement described below:

- **826 pH mobile (2.826.0XX0) or 827 pH lab (2.827.011X, 2.827.021X)**
- **pH electrode**
- **Calibration buffers**
Metrohm buffer solutions pH 4.00 and pH 7.00

The calibration parameters for the pH mode are set for a calibration using two Metrohm buffers as default (see *Section 6.1.2*). If you want to use other buffers then the corresponding buffer type must be entered.

4.2 pH calibration



1 Start calibration with first buffer

- Start calibration with **<CAL>**
- Immerse pH electrode in buffer solution **pH 7** and confirm with **<OK>**
- If a temperature sensor is connected, the calibration temperature is being determined
- If no temperature sensor is connected:
enter the temperature with the arrow keys and confirm with **<OK>**
- The first buffer is being measured
- The following message is displayed after successful measurement:

 change buffer <OK>



2 Continue calibration with second buffer

- Remove pH electrode from first buffer and rinse with water
- Immerse pH electrode in second buffer solution **pH 4** and continue calibration sequence with **<OK>**
- The second buffer is being measured

3 Result

- Wait for potential measurement, the result will be displayed:

```
pH calibration
slope           99.34 %
pH(0)          7.009
T(NTC)         24.8 °C

CAL
└─ calibration ok
```



- After 30 s the pH meter will switch back automatically to the measurement display. This can also be done immediately with **<OK>** or **<QUIT>**.

3 Poor calibration data

- If the calibration data are outside the calibration parameters defined as the limits (see *Section 6.1.3*) then a corresponding message will be shown:

```
pH calibration
slope           91.80 %
pH(0)          7.027
T(NTC)         22.7 °C
yes: <OK>      no: <QUIT>

! cal. out of limits
```



- You can still accept the calibration data with **<OK>**, or reject it with **<QUIT>**.

4 Show calibration data

You can now display the calibration data under **param/ cal.data**.

5 Print calibration report

- Change to the menu **<< report >>** with the arrow keys **<◀>** or **<▶>**.
- Press **<OK>**.
- Select the report **cal** with the arrow keys **<◀>** or **<▶>** and start the printing with **<OK>**.

6 Possible error messages

- In case buffer pH 7 has been measured again by mistake, the following message is displayed:

 same buffer

Change the buffer and press **<OK>**. The calibration is being continued. The calibration can be canceled with **<QUIT>**.

- If the temperature difference is $> 2\text{ }^{\circ}\text{C}$ between the buffers, the following message is displayed:

 delta T $> 2\text{ }^{\circ}\text{C}$

Adjust the temperature and continue the calibration with **<OK>** or cancel it with **<QUIT>**

4.3 pH measurement

1 Select print criterion

- If the obtained measured value is to be printed out directly as a measuring point report then the required print criterion must be set (see Section 5.2):

configuration/print crit.: drift

2 Start measurement

- Immerse the pH electrode in the sample

3 Determine measured value

- You can read off the current pH value of the sample from the display. It is stable when the message  **drifting...** is no longer being displayed (preset drift threshold: 0.028 pH/min)¹.

4 Print measured value

- Change to the menu **<< print >>** with the arrow keys **<◀>** or **<▶>**.
- The output of a measuring point report on a printer is started with **<OK>**. Due to the print criterion **drift** the recording of the measurement and its output takes place only when the measured value is stable:

```
'mp
827 pH lab           01106  5.827.0010
print date          2005-02-08 15:43:01
pH =    4.612                22.8 °C NTC
=====
```

¹ Further preset drift thresholds:
for potential measurement: U/mV: 1.875 mV/min, for temperature measurement: t/°C: 0.974 °C/min

5 Configuration

The configuration menu contains all the instrument settings for the pH meter. These are independent of the mode. They continue to exist until they are edited or the permanent memory containing the instrument configuration is re-initialized (see *Section 8.3*).

All the settings of this menu are described in this section. For each point you will find all the possible entries or the valid entry range together with the default value. This will always be reset when the permanent memory of the pH meter is re-initialized. The default is written in bold type below.

Example:

```
print crit.      immed., time, drift, change, off
```

The print criterion defines at what point in time the report or the measured value is being printed. The printing is started immediately with the default value **immed.**.

5.1 Report

<< config >>

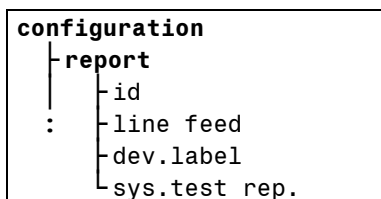

In the configuration menu **report** you can define the output format of the report header.

A report header containing all the elements described here could look like this:

Report identification:	'mp		
Device identification (unchangeable):	827 pH lab	01106	5.827.0010
Device identification (changeable):	dev.label		lab 1a
Date, Time:	print date	2005-01-25	08:23:56
Remark	id		sample 1
	...		

id 8 ASCII characters

This is where you can define a short identification for the report header of the measuring point report and the calibration report (e. g. sample/electrode identification). This entry will be printed out only if an identification has been entered. This identification is saved with each measured value being stored (see *Section 7.2*) in order to label the measured values individually.

line feed 0...3...999

The paper feed of the printer at the end of a report can be set here. You can select the number of empty lines so that after the report has been printed out you can tear off the printed paper directly at a suitable point. The paper feed depends on the type of printer and has to be set accordingly.



Note!

The line feed must be set to **999** when using a A4 printer.

dev.label 8 ASCII characters

If you wish to assign the printed reports to a particular pH meter not only by the unchangeable device identification, you can enter any text here. This entry will be printed out in each report provided that an identification has been entered.

sys.test rep. on, off

After switching on the 826/827 pH meter a system diagnosis is carried out automatically. If this parameter is switched on, the result is printed automatically after switching on the pH meter.

5.2 Printing out measured values

<< config >>

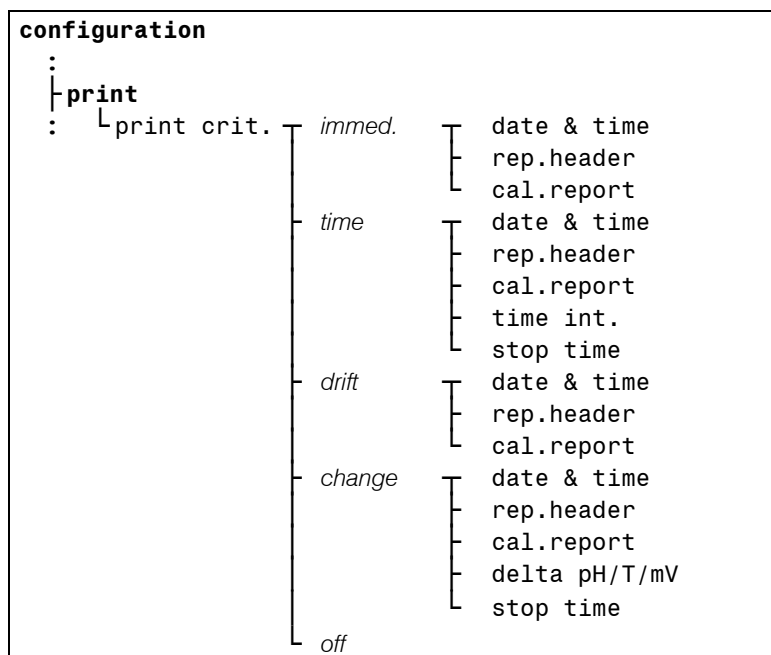

In the configuration menu **print** the output form of measured values, triggered by <OK> in the menu << **print** >> is defined.

print crit.: **immed.**, time, drift, change, off

Depending upon the print criterion a measured value report will be transmitted to a printer either **immediately**, at defined **time** intervals,

when the **drift** condition has been fulfilled or after a certain **difference of the measured value** has been exceeded.

```
print crit.:      immed.
```

With this setting a measured value report will be printed out after pressing **<OK>** in the menu **<< print >>**. The following options can be used:

date & time: **on, off**

Here you can choose whether the date and time at which the measured value was recorded are to be included with each individual measured value. This can take place irrespective of whether a report header is used.

rep.header: **once, always, off**

Normally each measured value is accompanied by the report header for documentation purposes. The exact contents of the report header are defined under **configuration/report** (see above).

With a larger series of manually triggered measurements it may be advisable to print out the report header only once with the first measured value. In this case all the measurements should be made under the same conditions.



Note!

The report header will only appear again when you switch off and on the pH meter again.

cal.report: **on, off**

You have the possibility of providing each measured value with the associated calibration data of the electrode used, e. g. within the context of a GLP documentation.

```
print crit.:      time
```

With this print criterion you can automatically record and output the measured values at fixed intervals. The following options are used:

date & time: **on, off**

rep.header: **once, always, off**

cal.report: **on, off**

These settings correspond to those of the print criterion '**immed.**' (see above).

time int.: **1...4...99'999 s**

Automatic measuring value recording can be carried out at time intervals of down to 1 s. Please note that if small time intervals are used then the amount of data for each measured value must be

adapted accordingly, as otherwise the buffer memory of the connected printer would be filled too quickly. This means, for example, that the report header should only be printed out once at the start of a series of measurements. Otherwise data could be lost. In this case you should consider matching the measured value recording to the measured value memory (see Section 5.3).

stop time: 0...999'999 s

The time after which an automatic series of measurements is to be terminated can be entered in whole seconds. You can also let a series of measurements run indefinitely without a fixed stop time and then stop it manually with **<QUIT>** if you select the default value **'0 s'** for this setting.

print crit.: drift

If this print criterion is used, a measured value will be printed out after pressing **<OK>** in the menu **print** not until the message **drifting...** is no longer displayed.

date & time: on, off
rep.header: once, always, off
cal.report: on, off

These settings correspond to those of the print criterion **'immed.'** (see above).

print crit.: change

The next measured value is printed automatically not until the difference to the previous measured value is bigger than the parameter **delta pH/T/mV** defined here.

date & time: on, off
rep.header: once, always, off
cal.report: on, off

These settings correspond to those of the print criterion **'immed.'** (see above).

delta pH: 0.10...0.50...16.00 pH
delta T: 0.1...0.5...100.0 °C
delta mV: 0.1...30.0...999.9 mV

stop time: 0...999'999 s

The printout of the measured values is terminated when the stop time has elapsed or will continue indefinitely (**'0 s'**). A termination is always possible with **<QUIT>**.

5.3 Storing measured values

<< config >>

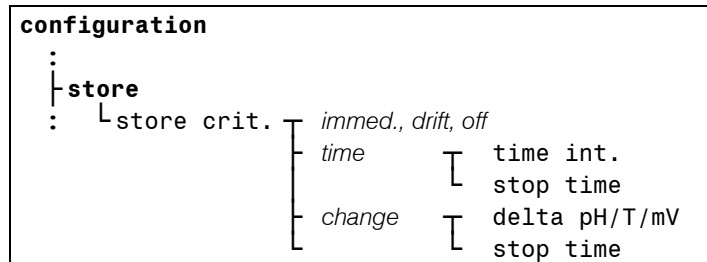

Up to 200 measured values can be stored manually or automatically after reaching the drift criterion, at definite time intervals or after changing by a certain amount (see Section 7.2). The storing is done by pressing **<OK>** in the menu **<< store >>**.

store crit.: **immed.**, time, drift, change, off

Depending upon the store criterion a measured value will be stored either **immediately**, at defined **time** intervals, when the **drift** condition has been fulfilled or after a certain **difference of the measured value** has been exceeded.

The following additional information are stored with each measured value:

- Temperature (Mode pH only)
- Id
- Date
- Time

store crit.: **immed.**

The current measured value is stored with **<OK>** if you are in the menu **<< store >>**.

store crit.: **time**

time int.: 1...4...99'999 s
 stop time: 0...999'999 s

You can automatically record and save the measured values at fixed time intervals until the stop time has been reached.

store crit.: **drift**

A measured value can only be stored if the message **drifting...** is no longer displayed.

store crit.: **change**

The next measured value is stored automatically not until the difference to the previous measured value is bigger than the parameter **delta pH/T/mV** defined here.

delta pH: 0.10...**0.50**...16.00 pH
 delta T: 0.1...**0.5**...100.0 °C
 delta mV: 0.1...**30.0**...999.9 mV

stop time: **0**...999'999 s

The storage of the measured values is terminated when the stop time has elapsed or will continue indefinitely ('**0 s**'). A termination is always possible with **<QUIT>**.

While storing the 200th measured value and each time a further storage attempt is made, the pH meter will produce a corresponding warning:

 **mv memory overflow**

You now have the possibility to view the stored measured values in the menu **<< recall >>** or to clear the whole measured value memory (see Section 7.2). It is also possible to output all measured values as a report via the infrared interface (see Section 7.1.7).

5.4 Auxiliaries

```

configuration
├── auxil
│   ├── last digit
│   ├── IR interface
│   ├── date
│   ├── time
│   ├── temp.sens.
│   ├── power save
│   └── progr.
  
```

Various basic settings for the configuration of the pH meter are made in this submenu.

last digit: on, **off**

Switch on this parameter if the pH values should be displayed with 3 decimal places and the potential with one decimal place respectively. The hiding can be useful in improving the readability of a rapidly changing measured value. Please note that this setting does not influence the drift control of a measurement. This setting refers only to the display.

IR interface on, **off**

The infrared interface is activated or deactivated respectively with this parameter. This parameter is deactivated by default.



Note!

*As soon as the alteration of this parameter has been confirmed with **<OK>**, the pH meter is switched off and on automatically.*

If the connection between pH meter and printer is working perfectly, it will be shown with the symbol  at the down left margin of the display.

If no printer is within the range of the infrared interface after switching on the pH meter or if the printer is switched off respectively, the following message is displayed:

⚠ **no IR connection**

Please consider the transmission range of the infrared interface (see *Section 2.2*) or switch on the printer respectively. The pH meter has to be switched off and on again.

date	YYYY-MM-DD
time	hh:mm:ss

You can set the date and time here. The program will only accept numbers which make sense.

temp.sens.: **NTC, Pt1000**

The 826/827 pH meter supports the use of two different types of temperature measuring techniques: NTC ('Negative Temperature Coefficient' semiconductor) and Pt1000 (platinum resistance thermometer). This means that the configuration must be adapted accordingly. If NTC sensors are used then it is also necessary to enter two sensor characteristics; these can be found in the specification of the sensor:

R (25 °C)	10'000...30'000...100'000
B value	1'000...4'100...9'999

The standard values $R(25\text{ °C}) = 30'000\ \Omega$ and $B\text{ value} = 4'100\ \text{K}$ apply to the use of a Metrohm electrode with NTC sensor (e. g. LL Primatrode NTC 6.0228.0X0), where the B value refers to 25 °C and 50 °C. B values of other NTC sensors are frequently based on different reference temperatures (usually 25 °C / 50 °C – 100 °C). When entering your own sensor characteristics the effect of the second reference temperature on the measuring accuracy of an NTC sensor is negligible.

power save: **off, 5, 15, 30, 60 min**

When this time interval has expired after the last operation the pH meter is switched off automatically.

progr.

This is the version number of the instrument software and cannot be altered. It is included in the report header as part of the device identification.

6 Methods / Parameters

The exact measuring method of the pH meter is described by parameters which, like the instrument configuration, are arranged in a tree structure in the menu display. The complete tree is shown in the appendix (see Section 9.2) to provide a better overview.

The parameters are set analogous to the instrument configuration. No parameters are available for the measuring modes U (mV) and T (°C). The menu << **param** >> is therefore not visible in these modes.

This means that one of the following subsections, together with the instrument configuration, forms a complete description of all the settings which are important for the operation of the pH meter in a particular measuring mode.

6.1 pH measurement (pH mode)

6.1.1 Measuring parameters

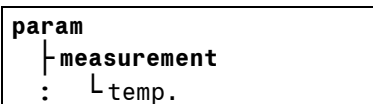

The measuring parameters describe the settings which are of direct importance for the measurement.

temp. : -999.9...25.0...999.9 °C

If no temperature sensor is connected, you can enter the temperature of the sample solution here. Otherwise the temperature is measured continuously and this value will be ignored. In case that the measuring and calibration temperatures are different, then it is necessary to record the temperature for the automatic correction of the electrode slope (temperature compensation). Information about the measuring temperature is also absolutely necessary for the complete documentation of a pH value. In the report printout of the measured value this manually determined temperature is indicated by the suffix '**man.**'.

6.1.2 Calibration parameters

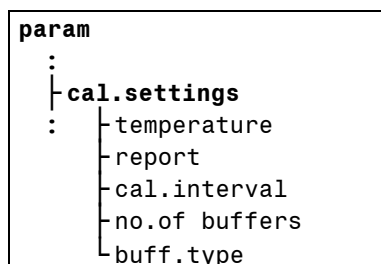

The calibration parameters describe the most important settings for the calibration such as buffer types and number of buffers.

temperature **0.0...25.0...99.9 °C**

Just as for the measuring temperature, the calibration temperature should also be entered when no temperature sensor is connected. Otherwise the temperature is measured continuously and this value will be ignored. If the measuring and calibration temperatures are different, then this is absolutely necessary for the automatic temperature correction of the electrode slope. The temperature is also stored with the suffix '**manual**' and marked in this way in the calibration report.

The exact temperature recording is also important for the pH calibration as the pH meter works with automatic buffer recognition (see below: **buff.type**).

report: **on, off**

After the calibration it is possible to output the calibration data automatically as a report.

Such a report can also be printed out at a later date.

cal.interval **0...999 h, 0 = off**

The pH meter can automatically remind you about any recalibration of the pH electrode used. When this interval has elapsed, a message will appear on the display:

 **cal.interval exp.**

This message can be deleted from the display with **<QUIT>**. It is displayed again every 10 min until a new calibration has been carried out. Until then it will be printed out on every measuring point report.



Note!

The calibration interval is only valid after the next calibration.

no.of buffers 1...2...3

Up to 3 buffers can be used for the pH calibration. If the calibration is carried out with only one buffer then the program will use the theoretical value of 100.0 % for the slope. This also applies when a calibration with several buffers is canceled with **<QUIT>** after the first buffer has been measured and then confirmed with **<OK>**.

Enter **"3"** if you carry out a 2-point calibration but wish to measure the second buffer twice in order to give it more statistical weight.

buff.type: **Metrohm, NIST, DIN, Fisher, Fluka BS, Mettler, MerckTitrisol, MerckCertiPUR, Beckman, Radiometer, Baker, Hamilton, Precisa, special**

For the automatic temperature-specific buffer recognition during the calibration, information about the type of buffer used is required. In the pH meter the temperature-dependent pH values of reference buffer solutions and technical buffer solutions from some suppliers are stored. Such a buffer table for Metrohm buffers looks like this:

Metrohm buffers			
T [°C]	pH 4.00	pH 7.00	pH 9.00
0	3.99	7.11	9.27
5	3.99	7.08	9.18
10	3.99	7.06	9.13
15	3.99	7.04	9.08
20	3.99	7.02	9.04
25	4.00	7.00	9.00
30	4.00	6.99	8.96
35	4.01	6.98	8.93
40	4.02	6.98	8.90
45	4.03	6.97	8.87
50	4.04	6.97	8.84
55	4.06	6.97	8.81
60	4.07	6.97	8.79
65	4.09	6.98	8.76
70	4.11	6.98	8.74
75	4.13	6.99	8.73
80	4.15	7.00	8.71
85	4.18	7.00	8.70
90	4.20	7.01	8.68
95	4.23	7.02	8.67

The other stored buffer tables are described in *Section 9.3*. During the calibration the pH meter shows the type and temperature-specific pH value of the recognized buffer. For temperatures within the 5 °C steps the pH value is linearly interpolated.

buff.type: special

If you would like to use different buffers from those described, then you require the exact pH value of each buffer at the temperature used for calibration. These pH values can be entered here. During the calibration they can again be adapted before each measurement.

A general rule is that you can only calibrate in defined temperature ranges, as otherwise the following error message appears:

 **buffer not defined**

6.1.3 Limits

```
param
:
| cal.limits
: | lo.lim.slope
  | up lim.slope
  | lo.lim.pH(0)
  | up lim.pH(0)
```

The most important calibration data such as slope and pH(0) must be within the limits defined here in order to be adopted automatically.

lo.lim.slope	1.0... 95.0 ...999.9 %
up lim.slope	1.0... 103.0 ...999.9 %
lo.lim.pH(0)	0.00... 6.40 ...99.99
up lim.pH(0)	0.00... 8.00 ...99.99

If one of the values of the calibration data lies outside these limits then at the end of the calibration the following message is displayed:

 **cal. out of limits**

You can accept these calibration data nevertheless with **<OK>** or you can reject them with **<QUIT>**.

6.1.4 pH calibration data

The current pH calibration data can be called up at any time under **param/cal.data**.

If no calibration has yet been carried out then only the theoretical calibration data slope = 100.00 % and pH(0) = 7.000 will be shown and taken into account for the measurement.

```

param
:
| cal.data
: | slope
  | pH(0)
  | variance
  | temperature
  | temp.sensor
  | cal.date
  | cal.time
  | cal.interval
  | buff.type
  | no.of buffers
    
```

slope

The slope of the linear calibration curve obtained during the calibration will be shown here as a percentage. This is a relative quantity which is based on the temperature-specific value of the Nernst constant (e. g. 59.16 mV at 25 °C). Due to the fact that only pH(0) can be calculated after a single buffer calibration, the slope is set to 100 %.

This value can be altered manually for test purposes.

pH(0)

This is the second characteristic quantity of the calibration curve. pH(0) is the pH value at 0 mV. It can also be altered manually for test purposes.



Note!

The manual alteration of either slope or pH(0) is documented by deleting the remaining calibration data.

variance

For the calibration with 3 buffers the calibration function will be calculated as a compensation curve according to the principle of the smallest mean-square error (linear regression). The resulting variance will be given here.

temperature

The calibration temperature is shown here.

temp.sensor

If the calibration temperature has been determined automatically by a connected temperature sensor then its type will be shown here ('**NTC**' or '**Pt1000**'). A manually entered temperature for the calibration will be indicated accordingly ('**manual**').

cal.date

The date of the calibration is shown here.

cal.time

The time of the calibration is shown here.

cal.interval

If a calibration interval has been defined under **param/cal.settings** then it will be shown here. It can be used together with the calibration time to estimate the time that the next calibration is due.

buff.type

The type of buffer defined in the calibration parameters at the time when calibration was carried out is shown here.

no.of buffers

The number of buffers actually measured is shown here. This can be lower than that given in the calibration parameters, as a calibration can be terminated prematurely with **<QUIT>**; only the buffers which have already been measured will then be used for the calculation of the calibration data.

6.2 Temperature measurement (T mode)

No editable parameters are necessary for this measuring mode. The menu **<< param >>** can therefore not be selected.

6.3 Potential measurement (U mode)

No editable parameters are necessary for this measuring mode. The menu **<< param >>** can therefore not be selected.

7 Various functions

This section describes various functions of the pH meter which cannot be assigned to individual modes.

7.1 Reports

A pH meter report is produced by transmitting data to a printer or computer via the infrared interface. In this way you can document e. g. measuring results, calibration data or the configuration of the instrument in written form.

A requirement for a properly functioning report output is the activation of the infrared interface (see *Section 5.4*).

The following reports can be printed automatically:

- **Calibration report:** The report of the current calibration can be printed additionally to each printed measuring point. Therefore activate the parameter **report** under **param/cal.settings**.
- **System test report:** The result of the system test after switching on the pH meter is printed out automatically if the parameter **sys.test rep.** under **configuration/report** is activated.

Apart from the measuring point report, all reports can be triggered manually at a later date via the menu **<< report >>**. The required report can be selected with the arrow keys **<◀>** or **<▶>** after confirming with **<OK>**:

cal	Calibration report
config	Instrument configuration report
param	Parameter report of the pH measurement
mval	Output of all stored measured values
pc/lims	Output of all stored measured values in machine readable form for storage with a PC
all	Output of all existing reports

The reports **cal** and **param** are only available in the pH mode.



Attention!

*The report output can be terminated at any time with **<QUIT>**. For this reason you should wait for the report output to be finished before operating the pH meter again. In this way you avoid the accidental cancellation of a report output.*

The following pages show the arrangement of reports together with the different types of reports.

7.1.1 Arrangement of a report

The first lines of a report provide a general description. This report header is configured under **configuration/report** (see *Section 5.1*):

```
Report Id: 'mp
Device Id: 827 pH lab           01106  5.827.0010
Date, Time: print date         2005-01-27  14:21:52
...
```

If you have entered a device identification (**dev.label**) under **configuration/report** then this will appear in the report header as an additional line between the device Id and the line date/time. A further definable identification for the report header (**id**) will appear subsequently to the line date/time (measuring point and calibration report only).

Each report is concluded with a finishing line. For an **automatically** triggered **original report** (measuring point or calibration report) this is in the form of a **double line**:

```
=====
```

Each report triggered **manually** via the menu **<< report >>** is concluded with a **single line**:

```
-----
```

7.1.2 Report identification

The report identification, known here as Report Id, is an abbreviation describing the type of report.

The following report Ids exist for the 826 pH mobile and 827 pH lab:

Report Id	Report name
'cr	pH calibration report
'co	configuration
'pa	parameter
'mv	measured values stored
'mp	measuring points
'md	measuring values to database (PC/LIMS)
'di	diagnosis

7.1.3 Measuring point report

<< print >>

By pressing the <OK> key in the menu << print >> a measuring point report will be produced. The following examples show versions of this type of report, the various configurations of which are defined under **configuration/print** (see Section 5.2).

A typical version of a measuring point report is the output of a single measured value. The print criterion '**immed.**' or '**drift**' must be selected.

```
'mp
827 pH lab           01106 5.827.0010
print date          2005-01-27 14:24:38
pH = 6.958          23.6 °C NTC
=====
```

If a whole series of measured values is to be documented then this is done by selecting the option **rep.header: once** under **configuration/print**. In this way the report header will be printed out once with the first measured value.



Note!

In order that the report header is printed again for a new series of measured values, the pH meter must be switched off and on again.

Each further time that the <OK> key is pressed a further measured value will be printed out:

```
pH = 6.963          23.6 °C NTC
pH = 6.968          23.6 °C NTC
pH = 6.969          23.6 °C NTC
```

Such a series of measured values can also be produced automatically by selecting the print criterion '**time**'.

With the print criterion '**change**' the next measured value is printed automatically not until the difference to the previous measured value is bigger than the value **delta pH/T/mV** defined under **configuration/print**.

7.1.4 Calibration report

<< report >>
cal

Subsequent to a calibration a calibration report can be printed out. Under **param/cal.settings/report** you can define whether this report is to be produced automatically after the measurement.

7.1.5 Configuration report

<< report >>
config

The current device settings are printed out with a configuration report.

7.1.6 Parameter report

<< report >>
param

The complete set of parameters of the mode pH is printed out with a parameter report. A parameter report can't be printed for the measuring modes U (mV) and T (°C) because these modes don't have any editable parameters.

7.1.7 Measured values memory report

<< report >>
mval

Up to 200 measured values can be stored in the menu << store >> (see *Section 7.2*). If you want to print out all the stored data then you can produce a measured values memory report.

The 'id' will only be included in the report if an identification has been entered under **configuration/report**.

7.1.8 PC/LIMS report

<< report >>
pc/lims

The PC/LIMS report is a machine readable report of all the stored measured values. It can be sent to a PC for storage (e. g. Metrohm Versuv[®] 3.0 for Windows[™]).

The PC/LIMS report has got the following structure:

```

Start of the data set: $$
Report identification: 'md
Device identification: 827 pH 1ab
Serial number: 01106
Program version: 5.827.0010
Device identification (dev.label): lab 1a
No. of measured value: #1
Measuring quantity 1: pH/U/T
Value: 4.477/165.3/24.3
Unit: --/mV/°C NTC
Measuring quantity 2 (temperature): T/--/--
Value: 23.8/--/--
Temperature unit, sensor type: °C NTC/--/--
Remark (id): sample 1
Date, time: 2005-01-31 17:05:39
Start of the data set: $E
-----

```

7.1.9 System test report

After the pH meter has been switched on an electronic system test is carried out automatically.

The tests are documented in the system test report which can be printed out when the pH meter is switched on: (see *Section 5.1*):

```
'di
827 pH lab          01106 5.827.0010
print date         2005-01-28 08:16:41
EPROM test        OK
ADC adjust test   OK
real time clock   OK
A/D converter     OK
LCD display       OK
=====
```



Note!

*The system test report can't be printed manually via the menu << **re-report** >>.*

If one of these tests is not concluded with '**OK**' then please contact Metrohm Service.

With a **real time clock** error you can try resetting the date and time. If the test is then '**OK**', you should check whether the instrument configuration is still unchanged.

7.2 Measured values memory

The pH meter can store up to 200 measured values with additional information. Depending on the storage criterion you can store the measured values immediately, at fixed time intervals, drift-controlled or after the change by a certain amount.

The appropriate instrument settings are made under **configuration/store**. A more detailed description of the configuration is given in *Section 5.3*.

7.2.1 Store measured values



Storing measured values is triggered with **<OK>** in the menu **<< store >>**. Each storage process is indicated with a message, e. g.:

```
mv 5 stored
```

While storing the 200th measured value, and after each further attempt to store a measured value, the pH meter will produce a warning message:

```
⚠ mv memory overflow
```

You now have the possibility to view the stored data or to delete the whole measured values memory in the menu **<< recall >>** (see *Section 7.2.3*).

7.2.2 Print measured values

The output of all stored measured values to a printer or computer via the infrared interface is made as a measured values memory report (see *Section 7.1.7*) or as a PC/LIMS report see *Section 7.1.8*). Select **mval** in the menu **<< report >>** for the measured values memory report or **pc/lims** for a PC/LIMS report respectively.

7.2.3 Show measured values

Call the dialog for displaying or deleting stored measured values in the menu **<< recall >>**:

```
meas.value memory
>show meas.val
del mv store:    no
```

Select the item **show meas.val** in order to access the corresponding **display**. The last measured value having been stored with the highest number will always be shown first:

	Measured value no.	No. of stored measured values
mv memory	6 of	6
pH	3.385	↑
T(NTC)	21.1 °C	
id		
date	2005-01-19	
time	09:47:22	↓



You can now use the two arrow keys <▲> and <▼> to leaf between the measured values.



In order to **delete all** measured values select the second parameter **del mv store:** in the above measured values memory menu and set it to 'yes' with <▶>; then confirm this and the following safety query **delete ?** with <OK>.



Note!

It is not possible to delete just individual measured values out of the measured values memory.

7.3 Setup

Certain settings of the pH meter can be found in the **setup** menu. This menu cannot be accessed from the normal instrument display, as alterations to these settings have a great influence on the functions of the pH meter.

The **setup** menu is called up by pressing down and holding down the **<CAL>** key while switching on the pH meter.

```

setup
  | lock
  | instr.number
  | instr.type
  | serial type
  | power type

```



Attention!

Be very careful when making alterations in this menu! Alterations have a very large influence on the functions of the instrument. Accidental alterations can be rejected by carrying out a deliberate RAM initialization (see Section 8.3).

7.3.1 Locking

```

Setup
  | lock
  : | all funct.
    | <CAL>

```

With **all funct.** you can disable all functions as well as the **<CAL>** key, e. g. to prevent unwanted alterations to the instrument settings. The measuring mode can be changed nevertheless. The **<CAL>** key can be locked separately.

You can activate such a disablement by setting the corresponding parameter to **'on'**. This does not affect access to the Setup menu in any way.

Please note that all disablements will be invalidated if a RAM-Init is carried out (see Section 8.3).

8 Troubleshooting – Messages – Maintenance

8.1 Troubleshooting

If problems occur during pH measurement then these can have various causes:

1. Application

Difficult sample matrices or interferences can prevent reliable measurements (e. g. insufficient ionic strength). Our **Application Bulletins** and **Application Notes** support you in correct selection of the analytical conditions. The most suitable electrode for your application can be found under www.metrohm.com.

2. Buffer solution

The precision of pH measurements depends primarily on the correct calibration of the electrode. You should use clean and fresh buffer solutions. For example, a frequent cause of incorrect calibration is the use of an old pH 9 or pH 10 buffer, whose pH can vary considerably from the certified pH of a new buffer as a result of the absorption of atmospheric CO₂.

3. Measuring / Reference electrode

The electrodes are the most important element of the whole measuring system. The correct handling of the measuring and reference electrodes is described in the **leaflet** which accompanies the electrode.

4. pH meter

If the pH meter is thought to be the cause of a measuring problem then first check all the configuration and parameter settings. The diagnostic functions help you in searching for the fault (see *Section 8.3*).









The pH meter will inform you directly about problems during the measurement. These **messages** are explained in the following *Section 8.2*. The following table lists general problems that can occur during pH measurements. Possible causes and appropriate remedies are also described.

<i>Problem</i>	<i>Possible cause</i>	<i>Remedy</i>
Measuring signal absent or very variable	Electrode not connected	<ul style="list-style-type: none"> • Connect electrode
	Air in or in front of the diaphragm	<ul style="list-style-type: none"> • Remove air
	Faulty electrode	<ul style="list-style-type: none"> • Replace electrode
Measured value remains unstable and does not fulfill drift criterion	Dirty glass membrane or diaphragm	<ul style="list-style-type: none"> • Clean membrane or diaphragm
	pH or temperature of the solution is not stable	<ul style="list-style-type: none"> • Measure under exclusion of air • Thermostat the solution
	Unsuitable electrode: <ul style="list-style-type: none"> • Conductivity too low • Organic solution 	<ul style="list-style-type: none"> • Use suitable electrode
	Electrode not connected	<ul style="list-style-type: none"> • Connect electrode
	Faulty electrode	<ul style="list-style-type: none"> • Replace electrode
Slow adjustment of measured value	Dirty glass membrane or diaphragm	<ul style="list-style-type: none"> • Clean membrane or diaphragm
Slope too small on calibration	Dirty glass membrane or diaphragm	<ul style="list-style-type: none"> • Clean membrane or diaphragm
	Glass membrane deswollen after measurement in non-aqueous solution	<ul style="list-style-type: none"> • Immerse electrode in water between measurements
	Poor buffer solutions	<ul style="list-style-type: none"> • Replace buffers
	Old Electrode	<ul style="list-style-type: none"> • Replace electrode
Measured value obviously incorrect	Incorrect calibration	<ul style="list-style-type: none"> • Check / Repeat calibration • Check / Replace buffers
	Manual temperature input incorrect	<ul style="list-style-type: none"> • Enter correct temperature of the solution
	Dirty glass membrane or diaphragm	<ul style="list-style-type: none"> • Clean membrane or diaphragm
	Electrolyte or electrode too old	<ul style="list-style-type: none"> • Refill electrolyte or replace electrode
	Faulty electrode	<ul style="list-style-type: none"> • Replace electrode

<i>Problem</i>	<i>Possible cause</i>	<i>Remedy</i>
No display after switching on despite mains connection (827 only)	Empty batteries	<ul style="list-style-type: none"> • Change batteries
System test message: Err #X	Instrument fault	<ul style="list-style-type: none"> • Note error number and inform Metrohm Service

8.2 Messages

The pH meter uses various messages to selectively inform you about possible errors or operating problems. These are shown in the bottom line of the display and illustrated by a symbol in front:

Type	Symbol	Example of a message
Error		same buffer
Warning		calibration data out of limits
Information		manual stop
		drifting measured value
		change buffer
		calibration OK
		infrared connection OK (symbol only, no message)
		battery low
Monitoring		calibration interval expired













These messages can normally be removed by pressing the **<QUIT>** key. However, some messages will remain until their cause has been remedied. For example, this applies to the mode T if no temperature sensor is connected.





Attention!

Please note that you should not press **<QUIT>** to acknowledge a message while a report is being produced as this will cancel the report.

The following table lists alphabetically all the messages which could appear on the display of the pH meter.

Message	Situation	Cause	Remedy
 battery low	Mode pH/U/T	The batteries are almost empty	Change batteries (see Section 8.4.1)
 buffer error	calibration	Buffer not recognized	1. Replace buffer 2. Press <OK>
 buffer not defined	calibration	pH value of a buffer has not been defined for the given temperature	pH values are only defined in the range of 0 ... 95 °C
 calibration OK	calibration	Calibration has been concluded successfully	Exit display with <OK> or <QUIT> ; this happens automatically after 30 s; calibration data will be accepted in either case
 cal. interval exp.	mode pH	Set calibration interval has expired	Recalibrate electrode (see Section 6.1.2)
 cal. out of limits	calibration	Determined calibration data are outside limits defined as calibration parameters	Accept calibration data with <OK> or reject them with <QUIT> ; check electrode, buffer or limits under 6.1.2 / 6.1.3
 change buffer <OK>	calibration	Instrument is waiting for new buffer	1. Change buffer 2. Press <OK>
 check T sensor	Mode T	Temperature sensor is faulty or not connected	Connect a properly functioning temperature sensor
 delta T >2 °C	calibration	Temperature difference between two buffers is too large	1. Match temperatures 2. Continue with <OK> or cancel with <QUIT> and restart
Err #X	System test after switch on	pH meter fault	1. Note error number 2. Contact Metrohm Service
 IR off	Print report / measured value	The IR interface is not activated	Activate the IR interface (see Section 5.4)
 manual stop	calibration	The calibration has been stopped manually	
 mv memory overflow	Saving measured values	Attempt made to store a further measured value when 200 have already been stored	Delete measured values (see Section 7.2)
 no IR connection		No connection with printer	1. Press <QUIT> 2. Switch on printer 3. Switch pH meter off and on again

Message	Situation	Cause	Remedy
 same buffer	calibration	Potential difference between 1 st and 2 nd buffer is less than 6 mV	1. Change buffer 2. Press <ENTER>
 - - - - - overrange	Mode pH/U/T	Measuring range exceeded	Remedy error or change mode

8.3 Diagnosis

The pH meter is equipped with a diagnosis program. This allows selective checks of the functions of individual assemblies.

The diagnosis is called up by pressing down and holding down the **<OK>** key while switching on the pH meter. Only those tests that you can carry out yourself are described below; the other functions are reserved for Metrohm Service personnel.

If one of the following tests is concluded with an error message, please note it down and contact your local Metrohm agency.



Attention!

You are expressly warned against triggering any other functions than those listed and documented below. Improper use can disturb the correct functioning of the pH meter and may render it unusable.

```
diagnose
- RAM init
- EEPROM init
- AD converter test
- LC display test
- key test
:
```

RAM init

The initialization of the instrument memory can be a good idea if you want to return parameter and configuration settings to their original condition.



Note!

The calibration data as well as the measured values memory won't be deleted with a RAM initialization.

EEPROM init

The calibration data and the measured values memory are deleted with an EEPROM initialization.

AD converter test

The electronic components of the analog-digital converter are checked. At the end the messages '**Init ADC ok**', '**Comm.test ADC ok**' and '**ADC Interrupt ok**' should appear.

LC display test

With this test you can check that the LCD display is functioning properly. It consists of a sequence of individual tests which can be switched forward with any key (except **<QUIT>**). After displaying the character set the test must be terminated with **<QUIT>**.

key test

The correct functions of all the instrument keys can be checked here. The instrument will respond to the pressing of each key by displaying the corresponding key code. This test is terminated by pressing the **<QUIT>** key twice.

Key	Code
<⏻>	2
<CAL>	5
<QUIT>	1
<OK>	7
<▲>	4
<▼>	6
<◀>	8
<▶>	3

8.4 Maintenance



Warning!

You should remove the batteries in case the pH meter is not used for a longer period. Leaking batteries can damage the pH meter.

8.4.1 Changing the batteries (826 only)

The 826 pH mobile reminds you of changing the batteries by displaying the message **"battery low"** and the symbol . The measurement accuracy is not affected at all.





Note!

All the parameters are reset to the default values. The current date and time are reset to 2005-01-01 and 00:00:00 respectively. The calibration data as well as the stored measured values are not lost.

Metrohm recommends using batteries of the type alkaline or lithium.

Proceed as follows:

-  Switch off the pH meter.
-  Unscrew the six screws on the base of the housing with the enclosed allen key and remove the base plate.

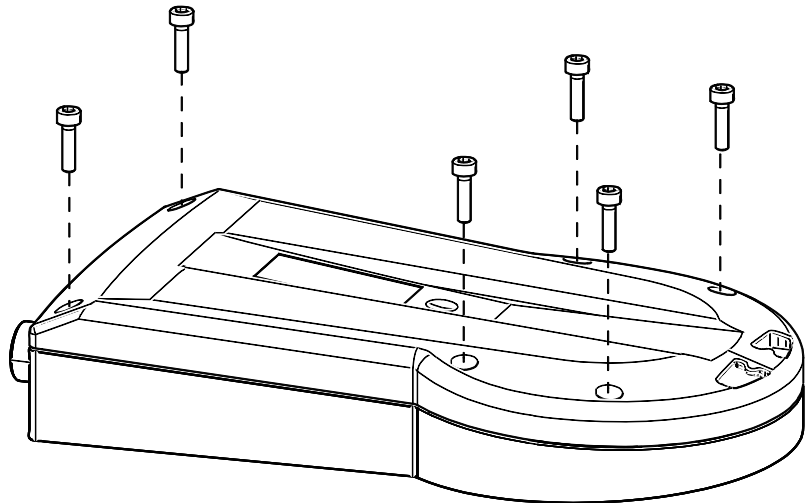

Fig. 5: Changing the batteries for the 826 pH mobile



Warning!

Do not remove the gray shielding plate under any circumstances and do not touch any electronic components.



- ☞ Exchange the existing four batteries for four new ones, type LR6/AA/AM3, 1.5 V (Metrohm order number 6.2133.000).
- ☞ Take care of the correct polarity of the batteries! The correct arrangement is shown in the battery compartment.
- ☞ Reattach the base plate with the six screws. Tighten the screws firmly (always crosswise) to ensure that the housing is tight.
- ☞ Switch on the pH meter. The following message is displayed:

⚠ set date and time

- ☞ Set the date and time correctly (see section 5.4).



Note!

In case that no electrode or no temperature sensor (mode T only) has been connected, the message above is overlaid by the message ⚠ overrange and is therefore not visible anymore.

8.4.2 Changing the batteries (827 only)

The 827 pH lab contains two batteries (type LR6/AA/AM3, 1.5 V) for the correct date and time as well as for switching on the instrument. In order to prevent leakage, the batteries should be replaced after approximately five years. The instrument reminds you of changing the batteries by displaying the message **"battery low"** and the symbol . The measurement accuracy is not affected at all.

Proceed as follows:

- ☞ Switch off the pH meter.
- ☞ Unscrew the five recessed head screws on the base of the housing and remove the base plate.

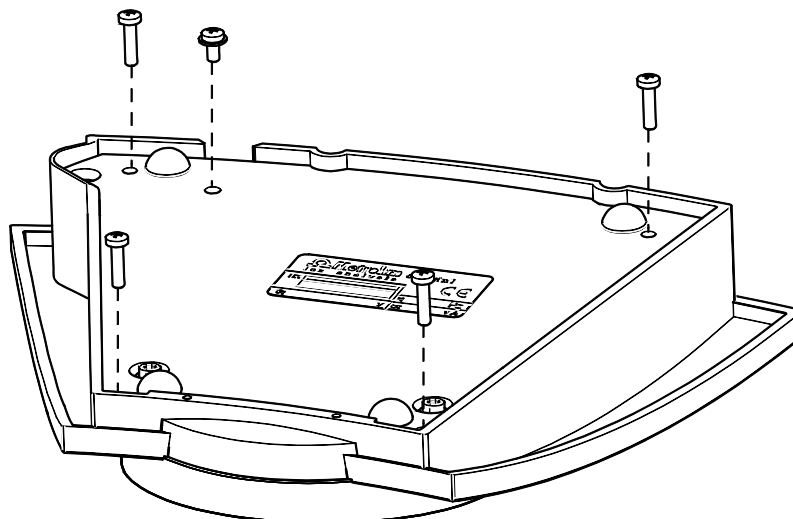

Fig. 6: Changing the batteries for the 827 pH lab

- ☞ Continue as described in the previous chapter.

9 Appendix

In this section you will find the most important technical data of the pH meter, dialog structures, a list of standard accessories and optional accessories as well as warranty and declarations of conformity.

9.1 Technical data

Provided that nothing to the contrary is mentioned, the published values represent the typical data of the **826 pH mobile** and the **827 pH lab**.

9.1.1 Measuring modes

<i>Measuring mode</i>	<i>Prim. measured quantity</i>	<i>Sec. measured quantity</i>
pH	pH	T
Temperature	T	
Potential	U	

9.1.2 Measuring inputs

Potentiometric

for pH value, potential

- 1 high-impedance measuring input for pH, redox and ISE electrodes
- 1 reference input for separate reference electrode

Input resistance > $1 \cdot 10^{12}$ Ohm (under reference conditions)

Temperature

Also for automatic temperature compensation

- 1 measuring input for temperature sensors (Pt1000 or NTC)

NTC characteristics configurable

Default values R (25°C) = 30'000 Ohm / $B_{25/50} = 4100$

Measuring interval

Measuring cycle 1 s for all measuring modes

9.1.3 Measuring input specifications

	Measuring range	Resolution	Measuring accuracy ¹⁾
<i>pH</i>	-8.000 ... +22.000	0.001 pH	± 0.003 pH
<i>Temperature</i>			
<i>Pt1000</i>	-150 °C ... +250 °C	0.1 °C	± 0.2 °C (-20 °C ... +150 °C)
<i>NTC (30 kΩ)</i>	-5 °C ... +250 °C	0.1 °C	± 0.6 °C (+10 °C ... +40 °C)
<i>Potential</i>	-1200.0 mV ... +1200.0 mV	0.1 mV	± 0.2 mV

¹⁾ ±1 digit, without sensor error, under reference conditions

9.1.4 Measured values memory

Memory capacity 200 measured values, nonvolatile storage

9.1.5 Display

Display LC display b/w, 128 x 64 pixel, 65 mm x 35 mm

9.1.6 Interfaces

Infrared interface

IR Sending reports to an IrDA compatible printer (IrComm and IrLPT, not IrOBEX), IBM character set, Code page 437

9.1.7 Power supply

826 pH mobile

4 batteries 1.2 ... 1.5 V, type LR6, AA, AM3 or mignon
Battery life approx. 2 years (in operation for 1 hour/day with connected NTC temperature sensor and IR interface switched off, with alkaline batteries)

827 pH lab

Power supply unit 6 V, 0.1A
2 batteries 1.2 ... 1.5 V, type LR6, AA, AM3 or mignon for the clock

9.1.8 Housing specifications

826 pH mobile IP 66/67 (with connected splash-proof electrode plug I)
 IP 66: Protection against hose water
 IP 67: Protection against short-term immersion in water

9.1.9 Safety specifications

<i>Instrument 826/827</i>	Standards fulfilled: - EN/IEC 61010-1 - UL 61010-1 - CSA-C22.2 No. 61010-1 - EN/IEC 60529 (only 826) - Protection class III
---------------------------	--

9.1.10 Electromagnetic compatibility (EMC)

<i>Emission</i>	Standards fulfilled: - EN/IEC 61326-1 - EN/IEC 61000-6-3 - EN 55022 / CISPR 22
<i>Immunity</i>	Standards fulfilled: - EN/IEC 61326-1 - EN/IEC 61000-6-2 - EN/IEC 61000-4-2 - EN/IEC 61000-4-3 - EN/IEC 61000-4-4 (only 827) - EN/IEC 61000-4-5 (only 827) - EN/IEC 61000-4-6 (only 827) - EN/IEC 61000-4-11 (only 827) - EN/IEC 61000-4-14 (only 827)

9.1.11 Ambient temperature

<i>Nominal working range</i>	-10 °C...+55 °C (max. 85 % rel. humidity)
<i>Storage</i>	-20 °C...+60 °C (≤ 65 % rel. humidity)
<i>Transport</i>	-40 °C...+60 °C

9.1.12 Reference conditions

<i>Ambient temperature</i>	+25 °C (±3 °C)
<i>Rel. humidity</i>	≤ 60%
<i>Device status</i>	> 30 min. in operation
<i>Validity of data</i>	After adjustment

9.1.13 Dimensions

826 pH mobile

<i>Housing material</i>	Polycarbonate / Acrylonitrile-butadiene-styrene (PC/ABS)
<i>Keyboard material</i>	Silicon rubber
<i>Display cover material</i>	Polymethyl methacrylate (PMMA)
<i>Width</i>	98 mm
<i>Height</i>	37 mm
<i>Depth</i>	183 mm
<i>Weight (without stand)</i>	370 g

827 pH lab

<i>Housing material</i>	Polycarbonate / Acrylonitrile-butadiene-styrene (PC/ABS)
<i>Keyboard material</i>	Silicon rubber
<i>Display cover material</i>	Polymethyl methacrylate (PMMA)
<i>Width</i>	210 mm
<i>Height</i>	45 mm
<i>Depth</i>	183 mm
<i>Weight (without stand)</i>	900 g

9.2 Menu structures

The menu structures of the instrument configuration and the parameters of all operating modes are shown on the following pages.

9.2.1 Instrument configuration

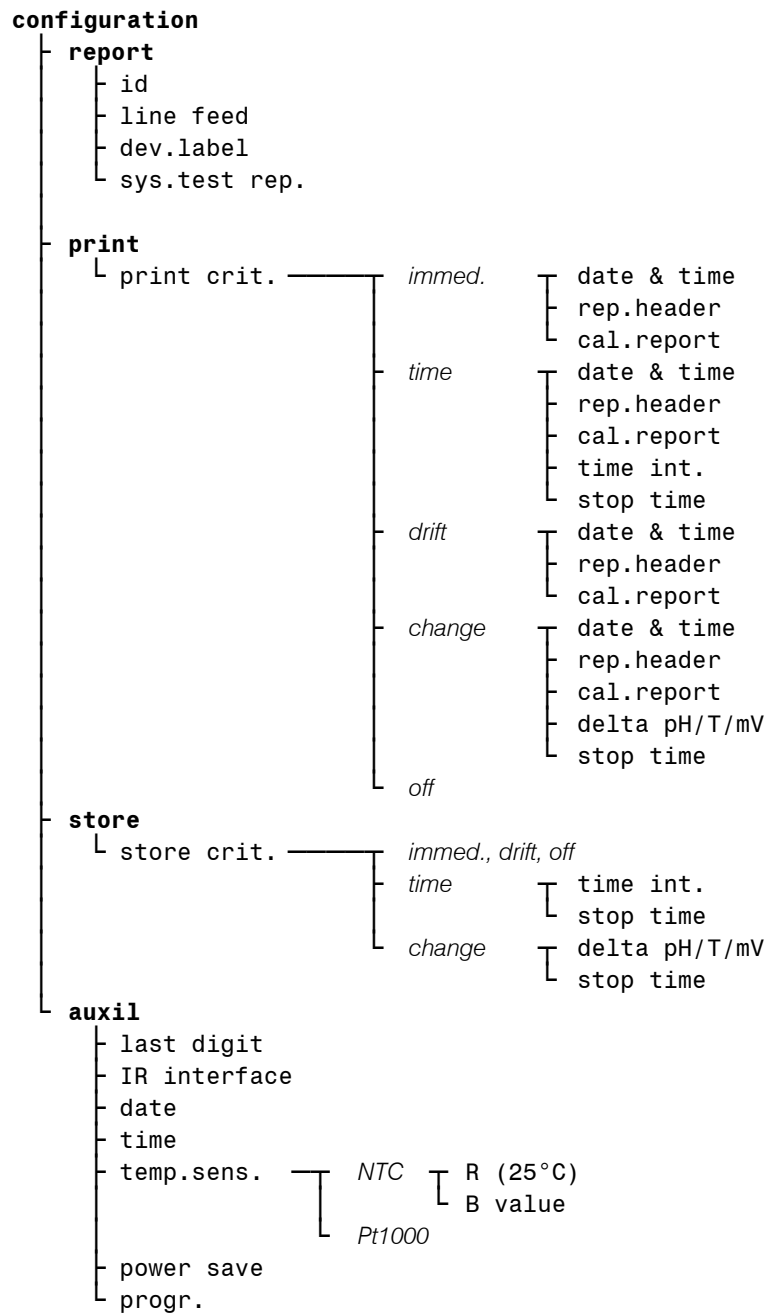

9.2.2 Parameters in the pH mode

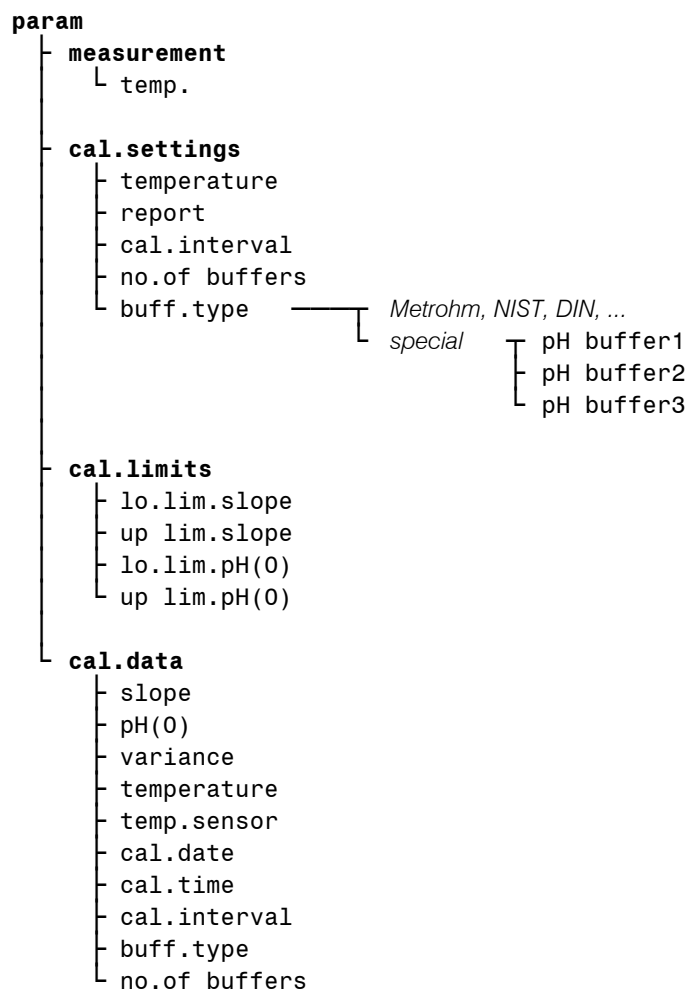

9.2.3 Parameters in the T mode

No editable parameters are necessary for this measuring mode. The menu << **param** >> can therefore not be selected.

9.2.4 Parameters in the U mode

No editable parameters are necessary for this measuring mode. The menu << **param** >> can therefore not be selected.

9.3 Stored buffer series

For automatic buffer recognition during pH calibration the temperature-dependent pH values of several common pH buffers are stored in the 826/827 pH meter. Apart from the Metrohm buffer solutions other reference and technical buffers are also included in the tables.

The following tables provide an overview of the stored pH(T) series:

The pH values printed in bold are the values at the reference temperature of the particular buffer set.

The pH values marked with ¹⁾ are interpolated or extrapolated values, all the others correspond to the manufacturer's specifications.

Temp. (°C)	Metrohm			NIST (according to DIN standard 19266, 2000)				
	Met4 pH 4.00	Met7 pH 7.00	Met9 pH 9.00	NIST1 pH 1	NIST4 pH 4	NIST7 pH 7	NIST9 pH 9	NIST13 pH 13
0	3.99	7.11	9.27	-	4.010	6.984	9.464	13.423
5	3.99	7.08	9.18	1.668	4.004	6.950	9.392	13.207
10	3.99	7.06	9.13	1.670	4.001	6.922	9.331	13.003
15	3.99	7.04	9.08	1.672	4.001	6.900	9.277	12.810
20	3.99	7.02	9.04	1.676	4.003	6.880	9.228	12.627
25	4.00	7.00	9.00	1.680	4.008	6.865	9.184	12.454
30	4.00	6.99	8.96	1.685	4.015	6.853	9.144	12.289
35	4.01	6.98	8.93	1.691	4.025	6.843	9.107	12.133
40	4.02	6.98	8.90	1.697	4.036	6.837	9.076	11.984
45	4.03	6.97	8.87	1.704	4.049	6.834	9.046	11.841
50	4.04	6.97	8.84	1.712	4.064	6.833	9.018	11.705
55	4.06	6.97	8.81	1.715	4.075	6.834	8.985	11.574
60	4.07	6.97	8.79	1.723	4.091	6.836	8.962	11.449
65	4.09	6.98	8.76	1.732 ¹⁾	4.108 ¹⁾	6.840 ¹⁾	8.941 ¹⁾	-
70	4.11	6.98	8.74	1.743	4.126	6.845	8.921	-
75	4.13	6.99	8.73	1.754 ¹⁾	4.145 ¹⁾	6.852 ¹⁾	8.902 ¹⁾	-
80	4.15	7.00	8.71	1.766	4.164	6.859	8.885	-
85	4.18	7.00	8.70	1.778 ¹⁾	4.185 ¹⁾	6.867 ¹⁾	8.867 ¹⁾	-
90	4.20	7.01	8.68	1.792	4.205	6.877	8.850	-
95	4.23	7.02	8.67	1.806	4.227	6.886	8.833	-

Temp. (°C)	DIN (according to DIN standard 19267, 1978)					
	DIN1 pH 1	DIN3 pH 3	DIN4 pH 4	DIN7 pH 7	DIN9 pH 9	DIN12 pH 12
0	1.08	-	4.67	6.89	9.48	-
5	1.08 ¹⁾	-	4.66 ¹⁾	6.86 ¹⁾	9.43 ¹⁾	-
10	1.09	3.10	4.66	6.84	9.37	13.37
15	1.09 ¹⁾	3.08 ¹⁾	4.65 ¹⁾	6.82 ¹⁾	9.32 ¹⁾	13.15 ¹⁾
20	1.09	3.07	4.65	6.80	9.27	12.96
25	1.09	3.06	4.65	6.79	9.23	12.75
30	1.10	3.05	4.65	6.78	9.18	12.61
35	1.10 ¹⁾	3.05 ¹⁾	4.66 ¹⁾	6.77 ¹⁾	9.13 ¹⁾	12.44 ¹⁾
40	1.10	3.04	4.66	6.76	9.09	12.29
45	1.10 ¹⁾	3.04 ¹⁾	4.67 ¹⁾	6.76 ¹⁾	9.04 ¹⁾	12.13 ¹⁾
50	1.11	3.04	4.68	6.76	9.00	11.98
55	1.11 ¹⁾	3.04 ¹⁾	4.69 ¹⁾	6.76 ¹⁾	8.97 ¹⁾	11.84 ¹⁾
60	1.11	3.04	4.70	6.76	8.92	11.69
65	1.11 ¹⁾	3.04 ¹⁾	4.71 ¹⁾	6.76 ¹⁾	8.90 ¹⁾	11.56 ¹⁾
70	1.11	3.04	4.72	6.76	8.88	11.43
75	1.12 ¹⁾	3.04 ¹⁾	4.74 ¹⁾	6.77 ¹⁾	8.86 ¹⁾	11.30 ¹⁾
80	1.12	3.05	4.75	6.78	8.85	11.19
85	1.12 ¹⁾	3.06 ¹⁾	4.77 ¹⁾	6.79 ¹⁾	8.83 ¹⁾	11.08 ¹⁾
90	1.13	3.07	4.79	6.80	8.82	10.99
95	-	-	-	-	-	-

Temp. (°C)	Fisher				Fluka Basel		
	Fis2 pH 2	Fis4 pH 4	Fis7 pH 7	Fis10 pH 10	FBS4 pH 4	FBS7 pH 7	FBS9 pH 9
0	-	4.01	7.13	10.34	4.01	7.11	9.20
5	1.98	3.99	7.10	10.26	4.00	7.08	9.15
10	1.98	4.00	7.07	10.19	4.00	7.05	9.10
15	2.02	3.99	7.05	10.12	4.00	7.02	9.05
20	2.00	4.00	7.02	10.06	4.00	7.00	9.00
25	2.00	4.00	7.00	10.00	4.01	6.98	8.96
30	2.00	4.01	6.99	9.94	4.01	6.97	8.91
35	2.02	4.02	6.98	9.90	4.02	6.96	8.88
40	2.01	4.03	6.97	9.85	4.03	6.95	8.84
45	2.01	4.04 ¹⁾	6.97 ¹⁾	9.81 ¹⁾	4.04	6.94	8.80
50	2.01	4.06	6.97	9.78	4.06	6.94	8.77
55	-	4.07 ¹⁾	6.97 ¹⁾	9.74 ¹⁾	4.07	6.93	8.74
60	-	4.09	6.98	9.70	4.09	6.93	8.71
65	-	4.11 ¹⁾	6.99 ¹⁾	9.68 ¹⁾	4.11 ¹⁾	6.93 ¹⁾	8.69 ¹⁾
70	-	4.13 ¹⁾	7.00 ¹⁾	9.65 ¹⁾	4.13	6.94	8.67
75	-	4.14 ¹⁾	7.02 ¹⁾	9.63 ¹⁾	4.14 ¹⁾	6.94 ¹⁾	8.65 ¹⁾
80	-	4.16 ¹⁾	7.03 ¹⁾	9.62 ¹⁾	4.16	6.95	8.63
85	-	4.18 ¹⁾	7.06 ¹⁾	9.61 ¹⁾	4.18 ¹⁾	6.96 ¹⁾	8.61 ¹⁾
90	-	4.21 ¹⁾	7.08 ¹⁾	9.60 ¹⁾	4.21	6.97	8.60
95	-	4.23 ¹⁾	7.11 ¹⁾	9.60 ¹⁾	4.23 ¹⁾	6.98 ¹⁾	8.59 ¹⁾

Temp. (°C)	Mettler Toledo					Beckmann		
	MT2 pH 2	MT4 pH 4	MT7 pH 7	MT9 pH 9	MT11 pH 11	Bec4 pH 4	Bec7 pH 7	Bec10 pH 10
0	2.03 ¹⁾	4.01 ¹⁾	7.12 ¹⁾	9.52 ¹⁾	11.90 ¹⁾	4.00	7.12	10.32
5	2.02	4.01	7.09	9.45	11.72	4.00	7.09	10.25
10	2.01	4.00	7.06	9.38	11.54	4.00	7.06	10.18
15	2.00	4.00	7.04	9.32	11.36	4.00	7.04	10.12
20	2.00	4.00	7.02	9.26	11.18	4.00	7.02	10.06
25	2.00	4.01	7.00	9.21	11.00	4.00	7.00	10.01
30	1.99	4.01	6.99	9.16	10.82	4.01	6.99	9.97
35	1.99	4.02	6.98	9.11	10.64	4.02	6.99	9.93
40	1.98	4.03	6.97	9.06	10.46	4.03	6.98	9.89
45	1.98	4.04	6.97	9.03	10.28	4.05	6.98	9.86
50	1.98	4.06	6.97	8.99	10.10	4.06	6.97	9.83
55	1.98 ¹⁾	4.08 ¹⁾	6.98 ¹⁾	8.96 ¹⁾	-	4.08	6.98	-
60	1.98 ¹⁾	4.10 ¹⁾	6.98 ¹⁾	8.93 ¹⁾	-	4.09	6.98	-
65	1.98 ¹⁾	4.13 ¹⁾	6.99 ¹⁾	8.90 ¹⁾	-	4.11	6.99	-
70	1.99 ¹⁾	4.16 ¹⁾	7.00 ¹⁾	8.88 ¹⁾	-	4.12	6.99	-
75	1.99 ¹⁾	4.19 ¹⁾	7.02 ¹⁾	8.85 ¹⁾	-	4.14	7.00	-
80	2.00 ¹⁾	4.22 ¹⁾	7.04 ¹⁾	8.83 ¹⁾	-	4.16	7.00	-
85	2.00 ¹⁾	4.26 ¹⁾	7.06 ¹⁾	8.81 ¹⁾	-	4.18	7.01	-
90	2.00 ¹⁾	4.30 ¹⁾	7.09 ¹⁾	8.79 ¹⁾	-	4.19	7.02	-
95	-	4.35 ¹⁾	7.12 ¹⁾	8.77 ¹⁾	-	4.21	7.03	-

Temp. (°C)	Radiometer			Baker			
	Rad4.01 pH 4.01	Rad7.00 pH 7	Rad9.18 pH 9.18	Bak4 pH 4.00	Bak7 pH 7.00	Bak9 pH 9.00	Bak10 pH 10.00
0	4.000	7.118	9.464	4.00	7.13	9.23	10.30
5	3.998	7.087	9.395	4.00 ¹⁾	7.09 ¹⁾	9.17 ¹⁾	10.24 ¹⁾
10	3.997	7.059	9.332	4.00	7.05	9.10	10.17
15	3.998	7.036	9.276	4.00 ¹⁾	7.03 ¹⁾	9.05 ¹⁾	10.11 ¹⁾
20	4.001	7.016	9.225	4.00	7.00	9.00	10.05
25	4.005	7.000	9.180	4.00 ¹⁾	6.98 ¹⁾	8.96 ¹⁾	10.00
30	4.011	6.987	9.139	4.01	6.98	8.91	9.96
35	4.018	6.977	9.102	4.02 ¹⁾	6.98 ¹⁾	8.88 ¹⁾	9.93 ¹⁾
40	4.027	6.970	9.068	4.03	6.97	8.84	9.89
45	4.038	6.965	9.038	4.04 ¹⁾	6.97 ¹⁾	8.81 ¹⁾	9.86 ¹⁾
50	4.050	6.964	9.011	4.05	6.96	8.78	9.82
55	4.064	6.965	8.985	4.07 ¹⁾	6.96 ¹⁾	8.76 ¹⁾	9.79 ¹⁾
60	4.080	6.968	8.962	4.08	6.96	8.73	9.76
65	4.097	6.974	8.941	4.10 ¹⁾	6.97 ¹⁾	8.71 ¹⁾	9.74 ¹⁾
70	4.116	6.982	8.921	4.12	6.97	8.69	9.72
75	4.137	6.992	8.900	4.14 ¹⁾	6.98 ¹⁾	8.68 ¹⁾	9.70 ¹⁾
80	4.159	7.004	8.885	4.16	6.98	8.66	9.68
85	4.183	7.018	8.867	4.19 ¹⁾	6.99 ¹⁾	8.64 ¹⁾	9.66 ¹⁾
90	4.210	7.034	8.850	4.21	7.00	8.62	9.64
95	4.240	-	-	-	-	-	-

Temp. (°C)	Hamilton DURACAL				Precisa		
	Ham4.01 pH 4.01	Ham7.00 pH 7.00	Ham9.21 pH 9.21	Ham10.01 pH10.01	Pre4 pH 4.00	Pre7 pH 7.00	Pre9 pH 9.00
0	-	-	-	-	3.99	7.11	9.27
5	4.01	7.09	9.45	10.19	3.99	7.08	9.18
10	4.00	7.06	9.38	10.15	3.99	7.06	9.13
15	4.00	7.04	9.32	10.11	3.99	7.04	9.08
20	4.00	7.02	9.26	10.06	3.99	7.02	9.04
25	4.01	7.00	9.21	10.01	4.00	7.00	9.00
30	4.01	6.99	9.16	9.97	4.00	6.99	8.96
35	4.02	6.98	9.11	9.92	4.01	6.98	8.93
40	4.03	6.97	9.06	9.86	4.02	6.98	8.90
45	4.04	6.97	9.03	9.83	4.03	6.97	8.87
50	4.06	6.97	8.99	9.79	4.04	6.97	8.84
55	-	-	-	-	4.06	6.97	8.81
60	-	-	-	-	4.07	6.97	8.79
65	-	-	-	-	4.09	6.98	8.76
70	-	-	-	-	4.11	6.98	8.74
75	-	-	-	-	4.13	6.99	8.73
80	-	-	-	-	4.15	7.00	8.71
85	-	-	-	-	4.18	7.00	8.70
90	-	-	-	-	4.20	7.01	8.68
95	-	-	-	-	4.23	7.02	8.67

Temp. (°C)	Merck Titrisol				
	Mer2 pH 2	Mer4 pH 4	Mer7 pH 7	Mer9 pH 9	Mer12 pH 12
0	2.01	4.05	7.13	9.24	12.58
5	2.01	4.04	7.07	9.16	12.41
10	2.01	4.02	7.05	9.11	12.26
15	2.00	4.01	7.02	9.05	12.10
20	2.00	4.00	7.00	9.00	12.00
25	2.00	4.01	6.98	8.95	11.88
30	2.00	4.01	6.98	8.91	11.72
35	2.00	4.01	6.96	8.88	11.67
40	2.00	4.01	6.95	8.85	11.54
45	2.00 ¹⁾	4.00 ¹⁾	6.95 ¹⁾	8.82 ¹⁾	11.44 ¹⁾
50	2.00	4.00	6.95	8.79	11.33
55	2.00 ¹⁾	4.00 ¹⁾	6.95 ¹⁾	8.76 ¹⁾	11.19 ¹⁾
60	2.00	4.00	6.96	8.73	11.04
65	2.00 ¹⁾	4.00 ¹⁾	6.96 ¹⁾	8.715 ¹⁾	10.97 ¹⁾
70	2.01	4.00	6.96	8.70	10.90
75	2.01 ¹⁾	4.00 ¹⁾	6.96 ¹⁾	8.68 ¹⁾	10.80 ¹⁾
80	2.01	4.00	6.97	8.66	10.70
85	2.01 ¹⁾	4.00 ¹⁾	6.98 ¹⁾	8.65 ¹⁾	10.59 ¹⁾
90	2.01	4.00	7.00	8.64	10.48
95	-	4.00 ¹⁾	7.02 ¹⁾	-	-

Temp. (°C)	Merck CertiPUR (25 °C)			
	MerC4.01 pH 4.01	MerC7.00 pH 7.00	MerC9.00 pH 9.00	MerC10.00 pH 10.00
0	-	-	-	-
5	4.00	7.09	9.22	10.22
10	4.00	7.06	9.16	10.16
15	4.00	7.04	9.10	10.10
20	4.00	7.02	9.05	10.05
25	4.01	7.00	9.00	10.00
30	4.01	6.98	8.96	9.94
35	4.03	6.98	8.93	9.90
40	4.03	6.97	8.89	9.86
45	4.05	6.97	8.87	9.80
50	4.06	6.97	8.84	9.73
55	-	-	-	-
60	-	-	-	-
65	-	-	-	-
70	-	-	-	-
75	-	-	-	-
80	-	-	-	-
85	-	-	-	-
90	-	-	-	-
95	-	-	-	-

When using Merck CertiPUR (20 °C) buffers, you have to select the buffer type "Merck Titrisol".



9.4 Scope of delivery

Immediately upon receipt of the instrument please check that the delivery is complete. The illustrations in the lists of accessories are not to the same scale.

9.4.1 826 pH mobile



Order no. 2.826.0010 (model version without electrode, without case)



The following accessories are included:

No.	Order no.	Description	
1	1.826.0010	826 pH mobile	
1	6.2050.000	Carrying strap	
1	6.2133.000	Set of 4 batteries, 1.5 V LR6	
1	6.2621.140	Hexagon key 2.5 mm	
1	8.827.8001EN	Instructions for Use for 826 pH mobile and 827 pH lab, english	
1	8.827.1203	Quick references for 826 pH mobile and 827 pH lab, english	

Order no. 2.826.0020 (model version electrode, without case)

The following accessories are included:

No.	Order no.	Description	
1	1.826.0010	826 pH mobile	
1	6.0228.020	LL Primatrode NTC comb. pH glass electrode with NTC temperature sensor, fixed cable plug I (splash-proof ac- cording to IP67) and 1 x 2 mm	
1	6.2050.000	Carrying strap	

1	6.2133.000	Set of 4 batteries, 1.5 V LR6.	
1	6.2621.140	Hexagon key 2.5 mm	
1	8.827.8001EN	Instructions for Use for 826 pH mobile and 827 pH lab, english	
1	8.827.1203	Quick references for 826 pH mobile and 827 pH lab, english	

Order no. 2.826.0110 (model version with electrode and case)

The following accessories are included:

No.	Order no.	Description	
1	1.826.0010	826 pH mobile	
1	6.0228.020	LL Primatrode NTC comb. pH glass electrode with NTC temperature sensor, fixed cable plug I (splash-proof ac- cording to IP67) and 1 x 2 mm	
1	6.1236.050	Sleeve SGJ 14, PE	
1	6.1446.000	Plastic stopper B-14(15), PP	
1	6.1613.020	Bottle 25 mL pH7 (without buf- fer), PE	
1	6.1613.030	Bottle 25 mL pH4 (without buf- fer), PE	
1	6.1614.000	Rinsing bottle 250 mL, PE	

3	6.1614.030	Bottle 50 mL, PP	
1	6.2050.000	Carrying strap	
1	6.2133.000	Set of 4 batteries, 1.5 V LR6	
1	6.2307.230	Buffer solutions pH 4 / 7 / 9 10 x 30 mL each	
1	6.2308.050	Electrolytic solution c(KCl) = 3 mol/L for Ag/AgCl reference systems, 50 mL	
1	6.2621.140	Hexagon key 2.5 mm	
1	6.2716.040	Case for 826 pH meter	
1	6.2717.000	Beaker 100 mL, PP	
1	8.827.8001EN	Instructions for Use for 826 pH mobile and 827 pH lab, english	
1	8.827.1203	Quick references for 826 pH mobile and 827 pH lab, english	





9.4.2 Optional accessories for 826 pH mobile



<i>Order no.</i>	<i>Valid for:</i>	<i>Description</i>
6.2307.230	2.826.0010 2.826.0020	Buffer solutions pH 4 / 7 / 9, 10 x 30 mL each
6.2325.000	2.826.0XX0	pHit kit, maintenance kit for pH electrodes
6.2103.180	2.826.0XX0	Adapter red, plug B (2 mm) / socket 4 mm
6.2103.190	2.826.0XX0	Adapter black, plug B (2 mm) / socket 4 mm

9.4.3 827 pH lab

Order no. 2.827.011X

The following accessories are included:



<i>No.</i>	<i>Order no.</i>	<i>Description</i>	
1	1.827.0010	827 pH lab	
1	6.0228.010	LL Primatrode NTC comb. pH glass electrode with NTC temperature sensor, fixed cable plug F and 1 x 2 mm	
1	6.2013.010	Clamping ring 10 mm for support rod	
1	6.2016.050	Support rod 300 mm	
1	6.2021.020	Electrode holder	
1	6.2161.010 6.2161.020 6.2161.030 6.2161.040	Power supply unit: EU 230V/6V DC US 120V/6V DC UK 230V/6V DC AUS 240V/6V DC	

1	6.2621.070	Hexagon key 5 mm	
1	V.0208.016	Recessed head screws	
1	8.827.8001EN	Instructions for Use for 826 pH mobile and 827 pH lab, english	
1	8.827.1203	Quick references for 826 pH mobile and 827 pH lab, english	

Order no. 2.827.021X

The following accessories are included:

No.	Order no.	Description	
1	1.827.0010	827 pH lab	
1	6.0258.600	LL Unitrode Pt1000 OK (Electrode head U)	
1	6.2104.600	Electrode cable for plug in head U/plug F 2x2 mm B, 1m	
1	6.2013.010	Clamping ring 10 mm for support rod	
1	6.2016.050	Support rod 300 mm	
1	6.2021.020	Electrode holder	
1	6.2161.010 6.2161.020 6.2161.030 6.2161.040	Power supply unit: EU 230V/6V DC US 120V/6V DC UK 230V/6V DC AUS 240V/6V DC	

1	6.2621.070	Hexagon key 5 mm	
1	V.0208.016	Recessed head screws	
1	8.827.8001EN	Instructions for Use for 826 pH mobile and 827 pH lab, english	
1	8.827.1203	Quick references for 826 pH mobile and 827 pH lab, english	

9.4.4 Optional accessories for 827 pH lab

<i>Order no.</i>	<i>Description</i>
6.2307.230	Buffer solutions pH 4 / 7 / 9, 10 x 30 mL each
6.2325.000	pHit kit, maintenance kit for pH electrodes
6.2103.180	Adapter red, plug B (2 mm) / socket 4 mm
6.2103.190	Adapter black, plug B (2 mm) / socket 4 mm

9.5 Warranty and conformity

9.5.1 Warranty

Metrohm guarantees that the deliveries and services it provides are free from material, design or manufacturing errors. The warranty period is 36 months from the day of delivery; for day and night operation it is 18 months. The warranty remains valid on condition that the service is provided by an authorized Metrohm service organization.





Glass breakage is excluded from the warranty for electrodes and other glassware. The warranty for the accuracy corresponds to the technical specifications given in the manual of the instrument. For components from third parties that make up a considerable part of our instrument, the manufacturer's warranty provisions apply. Warranty claims cannot be pursued if the Customer has not complied with the obligations to make payment on time.

During the warranty period Metrohm undertakes, at its own choice, to either repair at its own premises, free of charge, any instruments that can be shown to be faulty or to replace them. Transport costs are to the Customer's account.

Faults arising from circumstances that are not the responsibility of Metrohm, such as improper storage or improper use, etc. are expressly excluded from the warranty.





9.5.2 Declaration of Conformity

This is to certify the conformity to the standard specifications for electrical appliances and accessories, as well as to the standard specifications for security and to system validation issued by the manufacturing company.

<p><i>Name of commodity</i></p> <p>826 pH mobile</p>	 <p>CH-9101 Herisau/Switzerland E-Mail info@metrohm.com www.metrohm.com</p>
<p><i>Description</i> Portable pH meter for the measurement of pH, voltage and temperature; Connections for measuring electrode, reference electrode and temperature sensor.</p>	
<p>This instrument has been built and has undergone final type testing according to the standards:</p> <p><i>Electromagnetic compatibility: Emission</i> EN/IEC 61326-1: 2006, EN/IEC 61000-6-3: 2006, EN 55022 / CISPR 22: 2003</p> <p><i>Electromagnetic compatibility: Immunity</i> EN/IEC 61326-1: 2006, EN/IEC 61000-6-2: 2005, EN/IEC 61000-4-2: 2001, EN/IEC 61000-4-3: 2006</p> <p><i>Safety specifications</i> EN/IEC 61010-1: 2001, UL 61010-1: 2004, CSA-C22.2 No. 61010-1: 2004, EN/IEC 60529: 2000, protection class III</p>	
<p> <i>The instrument meets the requirements of the CE mark as contained in the EU directives 2006/95/EC (LVD), 2004/108/EC (EMC). It fulfils the following specifications:</i></p> <p>EN 61326-1 Electrical equipment for measurement, control and laboratory use – EMC requirements EN 61010-1 Safety requirements for electrical equipment for measurement, control and laboratory use</p>	
<p><i>Manufacturer</i> Metrohm Ltd. is holder of the SQS-certificate ISO 9001:2000 Quality management system for development, production and sales of instruments and accessories for ion analysis.</p>	
<p>Herisau, 18 November, 2010</p> <div style="display: flex; justify-content: space-around; align-items: flex-end;"> <div style="text-align: center;">  <p>D. Strohm Vice President, Head of R&D</p> </div> <div style="text-align: center;">  <p>A. Dellenbach Head of Quality Management</p> </div> </div>	

9.5.3 Declaration of Conformity

This is to certify the conformity to the standard specifications for electrical appliances and accessories, as well as to the standard specifications for security and to system validation issued by the manufacturing company.

<p><i>Name of commodity</i></p> <p>827 pH lab</p>	 <p>CH-9101 Herisau/Switzerland E-Mail info@metrohm.com www.metrohm.com</p>
<p><i>Description</i> Laboratory pH meter for the measurement of pH, voltage and temperature; Connections for measuring electrode, reference electrode and temperature sensor.</p>	
<p>This instrument has been built and has undergone final type testing according to the standards:</p> <p><i>Electromagnetic compatibility: Emission</i> EN/IEC 61326-1: 2006, EN/IEC 61000-6-3: 2006, EN 55022 / CISPR 22: 2003</p> <p><i>Electromagnetic compatibility: Immunity</i> EN/IEC 61326-1: 2006, EN/IEC 61000-6-2: 2005, EN/IEC 61000-4-2: 2001, EN/IEC 61000-4-3: 2006, EN/IEC 61000-4-4: 2004, EN/IEC 61000-4-5: 2006, EN/IEC 61000-4-6: 2007, EN/IEC 61000-4-11: 2004, EN/IEC 61000-4-14: 2004</p> <p><i>Safety specifications</i> EN/IEC 61010-1: 2001, UL 61010-1: 2004, CSA-C22.2 No. 61010-1: 2004, protection class III</p>	
<div style="display: flex; align-items: flex-start;"> <div style="font-size: 2em; margin-right: 10px;">  </div> <div> <p><i>The instrument meets the requirements of the CE mark as contained in the EU directives 2006/95/EC (LVD), 2004/108/EC (EMC). It fulfils the following specifications:</i></p> <p>EN 61326-1 Electrical equipment for measurement, control and laboratory use – EMC requirements</p> <p>EN 61010-1 Safety requirements for electrical equipment for measurement, control and laboratory use</p> </div> </div>	
<p><i>Manufacturer</i> Metrohm Ltd. is holder of the SQS-certificate ISO 9001:2000 Quality management system for development, production and sales of instruments and accessories for ion analysis.</p>	
<p>Herisau, 18 November, 2010</p> <div style="display: flex; justify-content: space-around; margin-top: 20px;"> <div style="text-align: center;">  <p>D. Strohm Vice President, Head of R&D</p> </div> <div style="text-align: center;">  <p>A. Dellenbach Head of Quality Management</p> </div> </div>	

9.5.4 Quality Management Principles

Metrohm Ltd., CH-9101 Herisau, Switzerland

 **Metrohm**
I o n a n a l y s i s
CH-9101 Herisau/Switzerland
E-Mail info@metrohm.com
Internet www.metrohm.com

Metrohm Ltd. holds the ISO 9001:2000 Certificate, registration number 10872-02, issued by SQS (Swiss Association for Quality and Management Systems). Internal and external audits are carried out periodically to assure that the standards defined by Metrohm's QM Manual are maintained.

The steps involved in the design, manufacture and servicing of instruments are fully documented and the resulting reports are archived for ten years. The development of software for PCs and instruments is also duly documented and the documents and source codes are archived. Both remain the possession of Metrohm. A non-disclosure agreement may be asked to be provided by those requiring access to them.

The implementation of the ISO 9001:2000 quality management system is described in Metrohm's QM Manual, which comprises detailed instructions on the following fields of activity:

Instrument development

The organization of the instrument design, its planning and the intermediate controls are fully documented and traceable. Laboratory testing accompanies all phases of instrument development.

Software development

Software development occurs in terms of the software life cycle. Tests are performed to detect programming errors and to assess the program's functionality in a laboratory environment.

Components

All components used in the Metrohm instruments have to satisfy the quality standards that are defined and implemented for our products. Suppliers of components are audited by Metrohm as the need arises.

Manufacture

The measures put into practice in the production of our instruments guarantee a constant quality standard. Production planning and manufacturing procedures, maintenance of production means and testing of components, intermediate and finished products are prescribed.

Customer support and service

Customer support involves all phases of instrument acquisition and use by the customer, i.e. consulting to define the adequate equipment for the analytical problem at hand, delivery of the equipment, user manuals, training, after-sales service and processing of customer complaints. The Metrohm service organization is equipped to support customers in implementing standards such as GLP, GMP, ISO 900X, in performing Operational Qualification and Performance Verification of the system components or in carrying out the System Validation for the quantitative determination of a substance in a given matrix.

10 Index

<hr/>	
<	
<⏻>	12
<◀, ▶>	12
<>, <>	13
<CAL>	12
<OK>	13
<QUIT>	12
<hr/>	
A	
Accuracy	55
AD converter test	51
Ambient temperature	56
Appendix	54
Arrow keys	12
Auxiliaries	28
<hr/>	
B	
B value	29
Battery changing	52
Buffer recognition	34
Buffer tables	60
Buffer type	
Calibration data	37
Calibration parameter	34
<hr/>	
C	
Calibration data	
Limits	35
Calibration date	37
Calibration interval	
Calibration data	37
Calibration parameter	33
Calibration parameters	33
Calibration report	24, 40
Calibration time	37
Change	
Print criterion	25
Store criterion	28
Configuration	22
Menu structure	58
Configuration report	40
Connection	
Electrodes/Sensors	7
Printer	9
Connections	3
<hr/>	
D	
Date	29
Device label	23
Diagnosis	50
Dimensions	56
Display	55
Drift	
Drift threshold	19
Print criterion	25
Store criterion	27
<hr/>	
E	
Editing	14
EEPROM init	50
Electrical safety	5
Electrodes	
Connection	7
Electromagn. compatibility	56
EMC	56
<hr/>	
F	
Faults	
General	46
Front view	2
<hr/>	
G	
General handling rules	5
Guarantee	71
<hr/>	
I	
Id	22
Immediate	
Print criterion	24
Store criterion	27
Infrared interface	28, 55
Init. of the instrument memory	50
Initial configuration	9
Input resistance	54
Installation	7
Instrument description	1
Instrument id	23
Instrument setup	7
Instrument versions	1
Interfaces	55
Introduction	1
<hr/>	
K	
Key test	51
Keys	
Functional description	12
Illustration	2
Lock	45
<hr/>	
L	
Last digit	28
LC display test	51
Limits	
pH(0)	35
Slope	35
Line feed	23
Locking	45
<hr/>	
M	
Meas. values memory report	41
Measured value display	11
Measured values	
Print	23, 43
Show	43
Store	27, 43
Measured values memory	43, 55
Measuring accuracy	55
Measuring interval	54
Measuring modes	54
Measuring parameters	32
Measuring point report	40
Measuring ranges	55
Memory initialization	50
Menu display	11
Menu structures	58
Messages	48
Metrohm buffers	34
<hr/>	
N	
No. of buffers	
Calibration data	37
Calibration parameter	34
Notations	4
NTC	
Characteristics	54
Configuration	29
<hr/>	
O	
ON/OFF	12
Operating tutorial	17
Operation	
Concept	11
Principles	14
<hr/>	
P	
Paper feed	23
Parameter report	41
Parameters	
Description	32
Menu structure	59
Parts and controls	2
PC/LIMS report	41
pH calibration	
Tutorial	17
pH calibration data	36
pH measurement	
Parameters	32
pH(0)	
Calibration data	36
Pictograms	4
Potential measurement	
Parameter	37
Power save	29
Power supply	55
Print criterion	24
Printer	
Connection	9
Program version	30

Pt1000			
Configuration	29		
R			
R (25 °C)	29		
RAM Initialization	50		
Rear view	3		
Reference conditions	56		
Report			
Arrangement	39		
Calibration data	33, 40		
Configuration	22, 40		
Finishing line	39		
Measured values memory	41		
Measuring points	40		
Output	38		
Overview	38		
Parameter	41		
PC/LIMS	41		
Selection	38		
System test	42		
Report header	22, 39		
Print criterion	24		
Report Id	39		
Report identification	39		
		Resolution	55
		S	
		Safety information	5
		Safety specifications	56
		Scope of delivery	65
		Sensors	
		Connection	7
		Setup	45
		Slope	
		Calibration data	36
		Stop time	
		Print criterion	25
		Store criterion	27
		Store criterion	27
		Stored buffer series	60
		Switch on	8
		System test	
		Description	42
		System test report	23, 42
		T	
		Technical data	54
		Temperature	
		Calibration data	37
		Calibration parameter	33
		Measuring parameter	32
		Temperature measurement	
		Parameters	37
		Temperature sensor	
		Calibration data	37
		Configuration	29
		Time	
		Configuration	29
		Print criterion	24
		Store criterion	27
		Time interval	
		Print criterion	25
		Store criterion	27
		Transport	7
		Troubleshooting	46
		V	
		Variance	
		Calibration data	36
		Various functions	38
		W	
		Warranty	71